











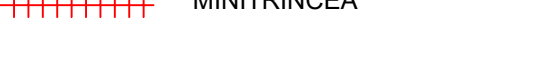







LEGENDA CIVILE

-  VINCOLO IDROGEOLOGICO REGIO DECRETO 3267/1923
-  TRINCEA TRADIZIONALE
-  MINITRINCEA
-  MICROTRINCEA
-  NO-DIG
-  CANALETTA EOF
-  RETE ED ESISTENTE AEREA
-  RETE ALTRI ESISTENTE AEREA
-  RETE ESISTENTE IP INTERRUATA
-  RETE ESISTENTE INTERRUATA
-  AREA PPP
-  AREA PFS
-  POZZETTO 76x40
-  POZZETTO 125x80
-  POZZETTO 90x70
-  POZZETTO 40x15
-  POZZETTO 45x45
-  POZZETTI TERZI ESISTENTI
-  COLONNINA PFS-ARMADIO
-  RFI-RETE FERROVIARIE DELLO STATO
-  SS-STRADA STATALE-ANAS
-  SP-STRADA PROVINCIALE



**REALIZZAZIONE, POSA IN OPERA E SERVIZIO DI MANUTENZIONE
DI IMPIANTI IN FIBRA OTTICA**

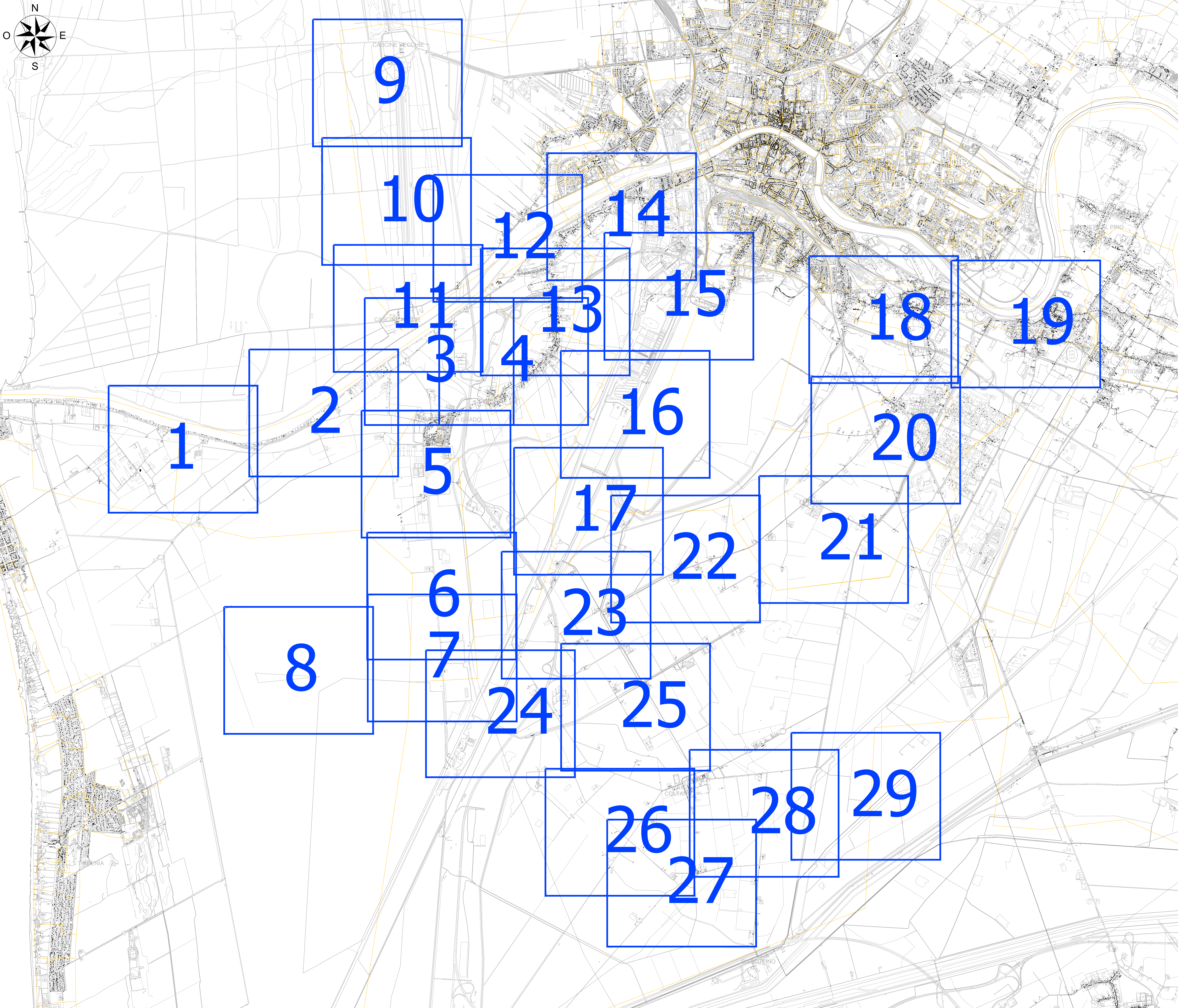

Comune di PISA
Via degli Uffizi, 1
56100 Pisa (PI)
comune.pisa@postacert.toscana.it

COMMITTENTE



REGIONAL MANAGER
REGIONE TOSCANA
MARCO GASPARINI

PROGETTISTA



ISTANZA DI AUTORIZZAZIONE

ELABORATO		DATA	
PLANIMETRIA SCAVI QUADRO DI UNIONE COMUNE DI PISA AREA_EST_PISA		REDAITTO	DATA
		VERIFICATO	
		APPROVATO	DATA
		1.0	19/06/2023
		1.1	-
		1.2	-
		CODICE PROGETTO	PISA
		FINANZIATO	PISA
		SCALA	1:16000
		NOME FILE	TAVOLA
		PISA-PL-S-EST-10	COROGRAFIA

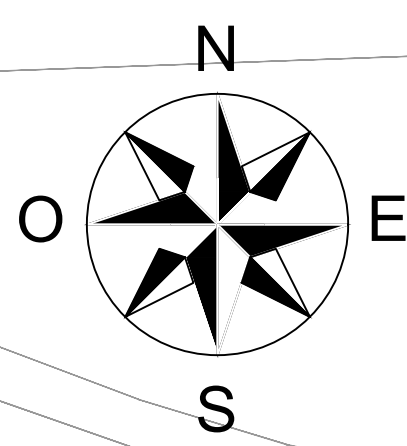

LEGENDA CIVILE

- VINCOLO IDROGEOLOGICO
REGIO DECRETO 3267/1923
- TRINCEA TRADIZIONALE
- MINITRINCEA
- MICROTRINCEA
- NO-DIG
- CANALETTA EOF
- RETE ED ESISTENTE AEREA
- RETE ALTRI ESISTENTE AEREA
- RETE ESISTENTE IP INTERRATA
- RETE ESISTENTE INTERRATA
- AREA PPP
- AREA PFS
- POZZETTO 76x40
- POZZETTO 125x80
- POZZETTO 90x70
- POZZETTO 48x15
- POZZETTO 45x45
- POZZETTI TERZI ESISTENTI
- COLONNINA PFS-ARMADIO
- RFI-RETE FERROVIARIE DELLO STATO
- SS-STRADA STATALE-ANAS
- SP-STRADA PROVINCIALE



REALIZZAZIONE, POSA IN OPERA E SERVIZIO DI MANUTENZIONE
DI IMPIANTI IN FIBRA OTTICA



Comune di PISA
Via degli Uffizi, 1
56100 Pisa (PI)
comune.pisa@postacert.toscana.it







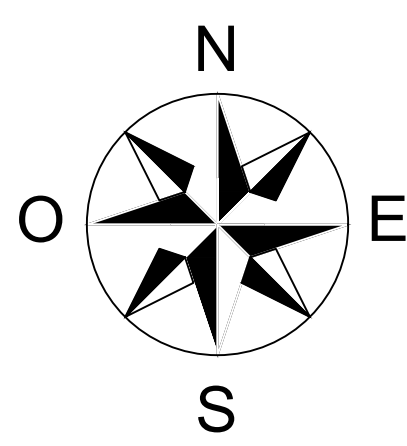





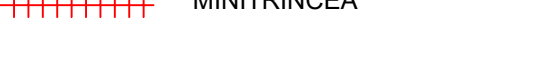





<p>COMMITTENTE</p> <p>REGIONAL MANAGER REGIONE TOSCANA MARCO GASPARIANI</p>	<p>PROGETTISTA</p>
---	--------------------

ISTANZA DI AUTORIZZAZIONE

ELABORATO PLANIMETRIA SCAVI DETTAGLIO COMUNE DI PISA AREA_EST_PISA			DATA	
			REDAITTO	
REVISIONE DATA AGGIORNAMENTI			VERIFICATO	
			APPROVATO	
1.0	19/06/2023	-	DATA	19/06/2023
1.1	-	-	SCALA	1:2000
1.2	-	-	NOME FILE	PISA-PL-S-EST-10
			CODICE PROGETTO FISA FINANZIATO	TAVOLA 1



LEGENDA CIVILE

-  VINCOLO IDROGEOLOGICO
REGIO DECRETO 3267/1923
-  TRINCEA TRADIZIONALE
-  MINITRINCEA
-  MICROTRINCEA
-  NO-DIG
-  CANALETTA EOF
-  RETE ED ESISTENTE AEREA
-  RETE ALTRI ESISTENTE AEREA
-  RETE ESISTENTE IP INTERRATA
-  RETE ESISTENTE INTERRATA
-  AREA PPP
-  AREA PFS
-  POZZETTO 76x40
-  POZZETTO 125x80
-  POZZETTO 90x70
-  POZZETTO 40x15
-  POZZETTO 45x45
-  POZZETTI TERZI ESISTENTI
-  COLONNINA PFS-ARMADIO
-  RFI-RETE FERROVIARIE DELLO STATO
-  SS-STRADA STATALE-ANAS
-  SP-STRADA PROVINCIALE



REALIZZAZIONE, POSA IN OPERA E SERVIZIO DI MANUTENZIONE
DI IMPIANTI IN FIBRA OTTICA

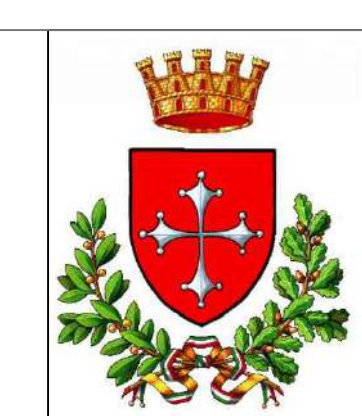

Comune di PISA
Via degli Uffizi, 1
56100 Pisa (PI)
comune.pisa@postacert.toscana.it

<p>COMMITTENTE</p>  <p>REGIONAL MANAGER REGIONE TOSCANA MARCO GASPARIANI</p>	<p>PROGETTISTA</p> 
---	--





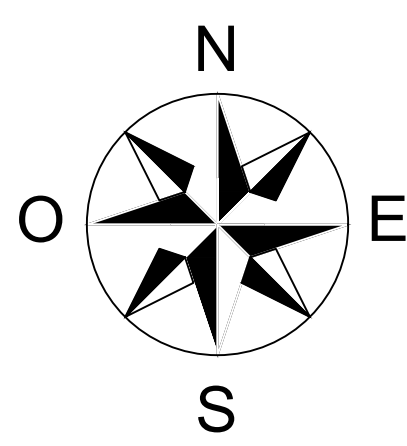





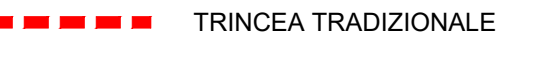

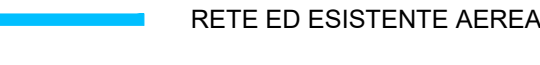

ISTANZA DI AUTORIZZAZIONE

ELABORATO		DATA	
PLANIMETRIA SCAVI DETTAGLIO COMUNE DI PISA AREA_EST_PISA			
REVISIONE	DATA	AGGIORNAMENTI	SCALA
1.0	19/06/2023	-	1:2000
1.1	-	-	-
1.2	-	-	-
		NOME FILE PISA-PL-S-EST-10	TAVOLA 2

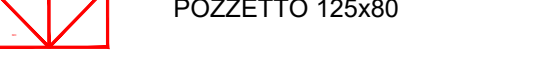

CASCINE NUOVE

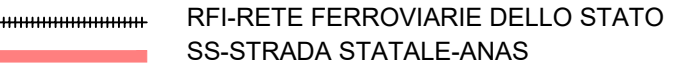
LEGENDA CIVILE

-  VINCOLO IDROGEOLOGICO
REGIO DECRETO 3267/1923
-  TRINCEA TRADIZIONALE
-  MINITRINCEA
-  MICROTRINCEA
-  NO-DIG
-  CANALETTA EOF
-  RETE ED ESISTENTE AEREA
-  RETE ALTRI ESISTENTE AEREA
-  RETE ESISTENTE IP INTERRATA
-  RETE ESISTENTE INTERRATA
-  AREA PPP
-  AREA PFS
-  POZZETTO 76x40
-  POZZETTO 125x80
-  POZZETTO 90x70
-  POZZETTO 48x15
-  POZZETTO 45x45
-  POZZETTI TERZI ESISTENTI
-  COLONNINA PFS-ARMADIO
-  RFI-RETE FERROVIARIE DELLO STATO
-  SS-STRADA STATALE-ANAS
-  SP-STRADA PROVINCIALE

REALIZZAZIONE, POSA IN OPERA E SERVIZIO DI MANUTENZIONE
DI IMPIANTI IN FIBRA OTTICA

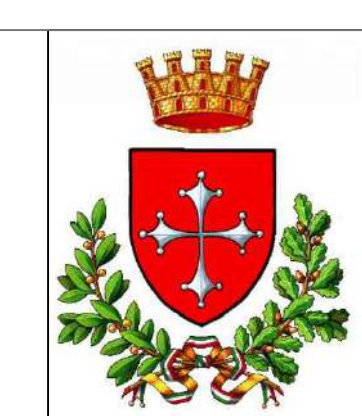

Comune di PISA
Via degli Uffizi, 1
56100 Pisa (PI)
comune.pisa@postacert.toscana.it







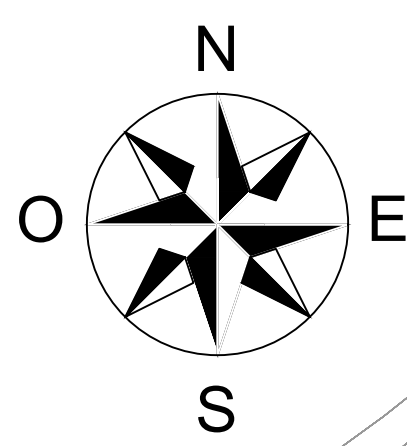





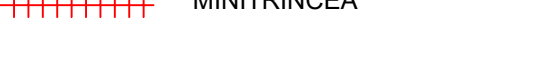





<p>COMMITTENTE</p>  <p>REGIONAL MANAGER REGIONE TOSCANA MARCO GASPARINI</p>	<p>PROGETTISTA</p> 
--	--

ISTANZA DI AUTORIZZAZIONE

ELABORATO PLANIMETRIA SCAVI DETTAGLIO COMUNE DI PISA AREA_EST_PISA			DATA	
			REDAITTO	
REVISIONE DATA AGGIORNAMENTI			VERIFICATO	
			APPROVATO	
1.0	19/06/2023	-	DATA	19/06/2023
1.1	-	-	SCALA	1:2000
1.2	-	-	NOME FILE	PISA-PL-S-EST-10
			CODICE PROGETTO	PISA
			FINANZIATO	PISA
			TAVOLA	3



LEGENDA CIVILE

-  VINCOLO IDROGEOLOGICO
REGIO DECRETO 3267/1923
-  TRINCEA TRADIZIONALE
-  MINITRINCEA
-  MICROTRINCEA
-  NO-DIG
-  CANALETTA EOF
-  RETE ED ESISTENTE AEREA
-  RETE ALTRI ESISTENTE AEREA
-  RETE ESISTENTE IP INTERRATA
-  RETE ESISTENTE INTERRATA
-  AREA PPP
-  AREA PFS
-  POZZETTO 76x40
-  POZZETTO 125x80
-  POZZETTO 90x70
-  POZZETTO 40x15
-  POZZETTO 45x45
-  POZZETTI TERZI ESISTENTI
-  COLONNINA PFS-ARMADIO
-  RFI-RETE FERROVIARIE DELLO STATO
-  SS-STRADA STATALE-ANAS
-  SP-STRADA PROVINCIALE

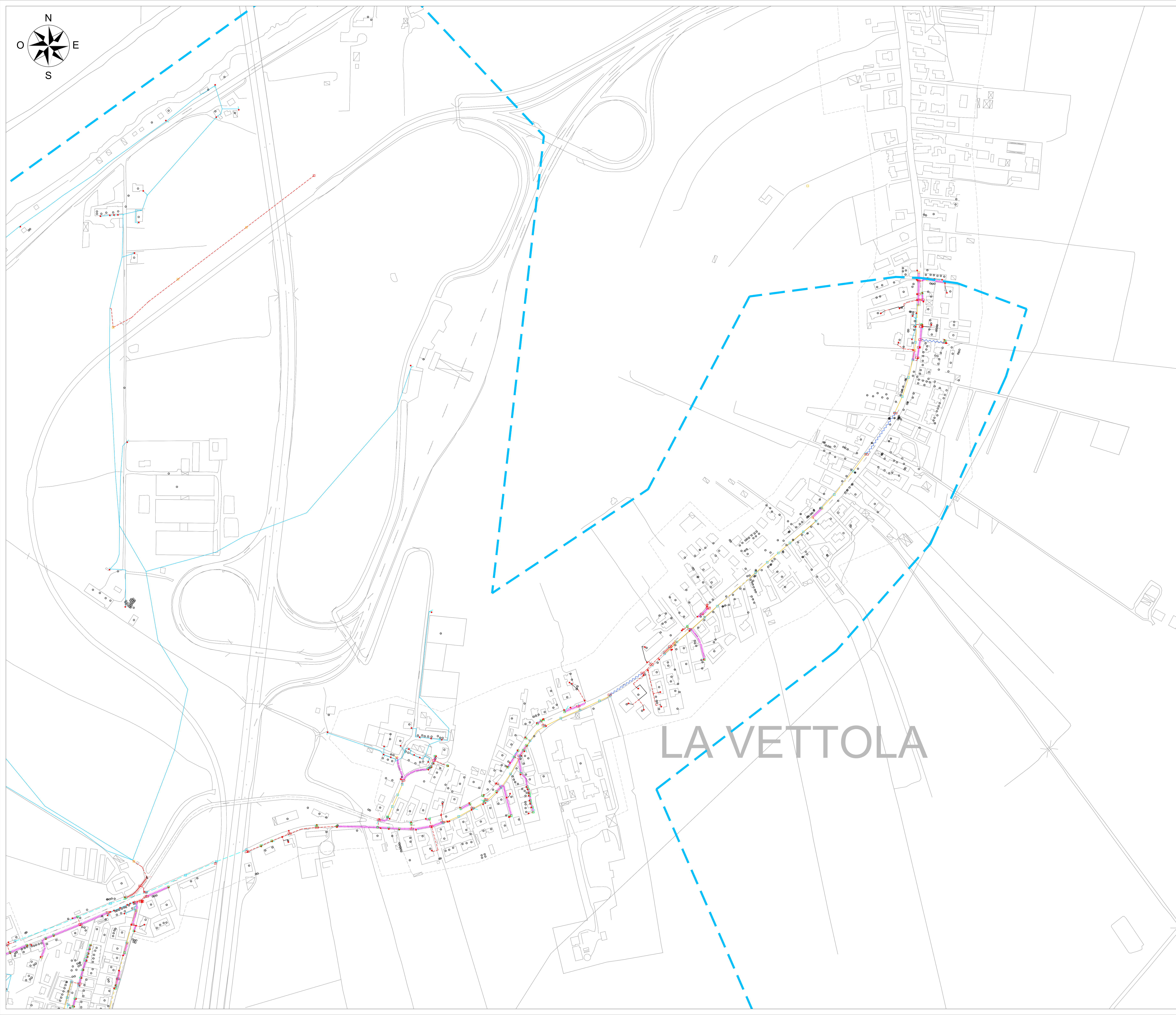

LA VETTOLA

REALIZZAZIONE, POSA IN OPERA E SERVIZIO DI MANUTENZIONE
DI IMPIANTI IN FIBRA OTTICA

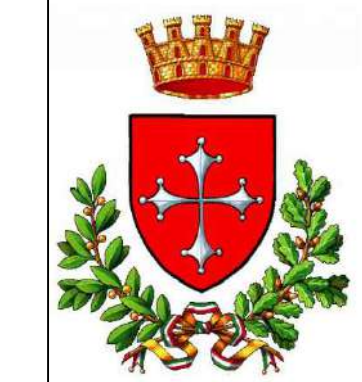

Comune di PISA
Via degli Uffizi, 1
56100 Pisa (PI)
comune.pisa@postacert.toscana.it

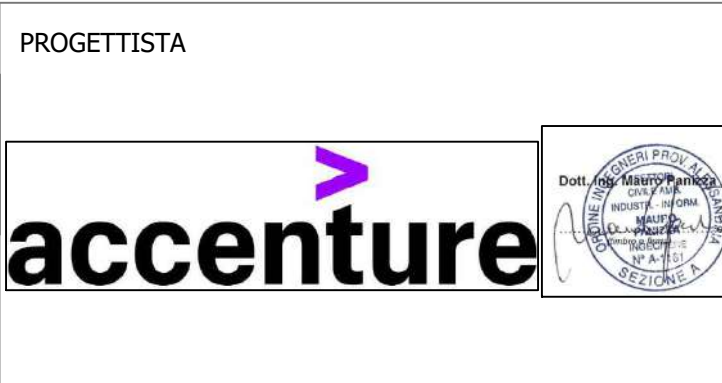

ISTANZA DI AUTORIZZAZIONE

ELABORATO		PLANIMETRIA SCAVI DETTAGLIO COMUNE DI PISA AREA_EST_PISA		DATA	
REVISIONE	DATA	AGGIORNAMENTI	SCALA	1:2000	TAVOLA
1.0	19/06/2023	-	NOME FILE	PISA-PL-S-EST-10	4
1.1	-	-			
1.2	-	-			

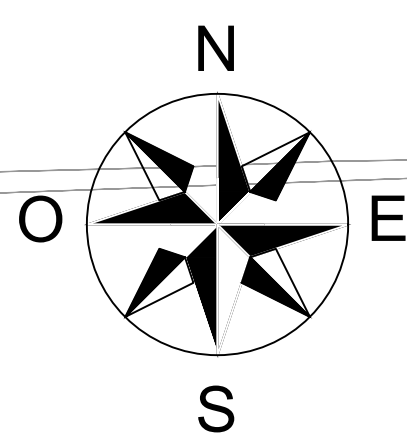

SAN PIERO A GRADO

LEGENDA CIVILE

-  VINCOLO IDROGEOLOGICO REGIO DECRETO 3267/1923
-  TRINCEA TRADIZIONALE
-  MINITRINCEA
-  MICROTRINCEA
-  NO-DIG
-  CANALETTA EOF
-  RETE ED ESISTENTE AEREA
-  RETE ALTRI ESISTENTE AEREA
-  RETE ESISTENTE IP INTERRATA
-  RETE ESISTENTE INTERRATA
-  AREA PPP
-  AREA PFS
-  POZZETTO 76x40
-  POZZETTO 125x80
-  POZZETTO 90x70
-  POZZETTO 40x15
-  POZZETTO 45x45
-  POZZETTI TERZI ESISTENTI
-  COLONNINA PFS-ARMADIO
-  RFI-RETE FERROVIARIE DELLO STATO
-  SS-STRADA STATALE-ANAS
-  SP-STRADA PROVINCIALE

REALIZZAZIONE, POSA IN OPERA E SERVIZIO DI MANUTENZIONE
DI IMPIANTI IN FIBRA OTTICA

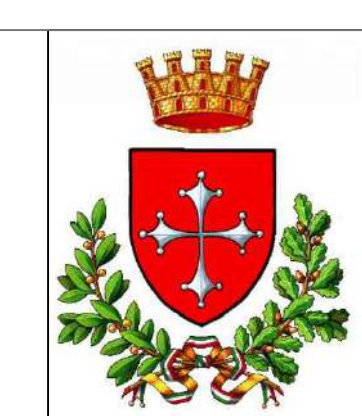



Comune di PISA
Via degli Uffizi, 1
56100 Pisa (PI)
comune.pisa@postacert.toscana.it

COMMITTENTE



REGIONAL MANAGER
REGIONE TOSCANA
MARCO GASPARINI

PROGETTISTA

ISTANZA DI AUTORIZZAZIONE

ELABORATO			DATA	
PLANIMETRIA SCAVI DETTAGLIO COMUNE DI PISA AREA_EST_PISA			REDAITTO	
			VERIFICATO	
			APPROVATO	
			DATA	19/06/2023
			CODICE PROGETTO	FISA
REVISIONE	DATA	AGGIORNAMENTI	SCALA	FISA FINANZIATO
1.0	19/06/2023	-	1:2000	
1.1	-	-	NOME FILE	TAVOLA
1.2	-	-	PISA-PL-S-EST-10	5

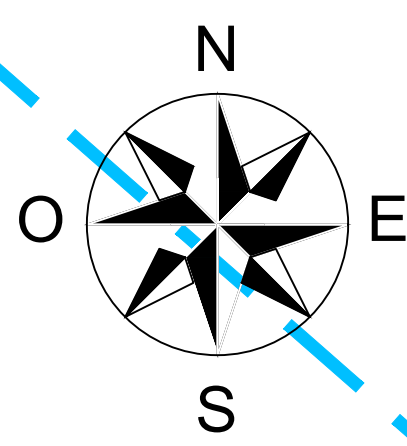

LEGENDA CIVILE

-  VINCOLO IDROGEOLOGICO
REGIO DECRETO 3267/1923
-  TRINCEA TRADIZIONALE
-  MINITRINCEA
-  MICROTRINCEA
-  NO-DIG
-  CANALETTA EOF
-  RETE ED ESISTENTE AEREA
-  RETE ALTRI ESISTENTE AEREA
-  RETE ESISTENTE IP INTERRATA
-  RETE ESISTENTE INTERRATA
-  AREA PPP
-  AREA PFS
-  POZZETTO 76x40
-  POZZETTO 125x80
-  POZZETTO 90x70
-  POZZETTO 40x15
-  POZZETTO 45x45
-  POZZETTI TERZI ESISTENTI
-  COLONNINA PFS-ARMADIO
-  RFI-RETE FERROVIARIE DELLO STATO
-  SS-STRADA STATALE-ANAS
-  SP-STRADA PROVINCIALE

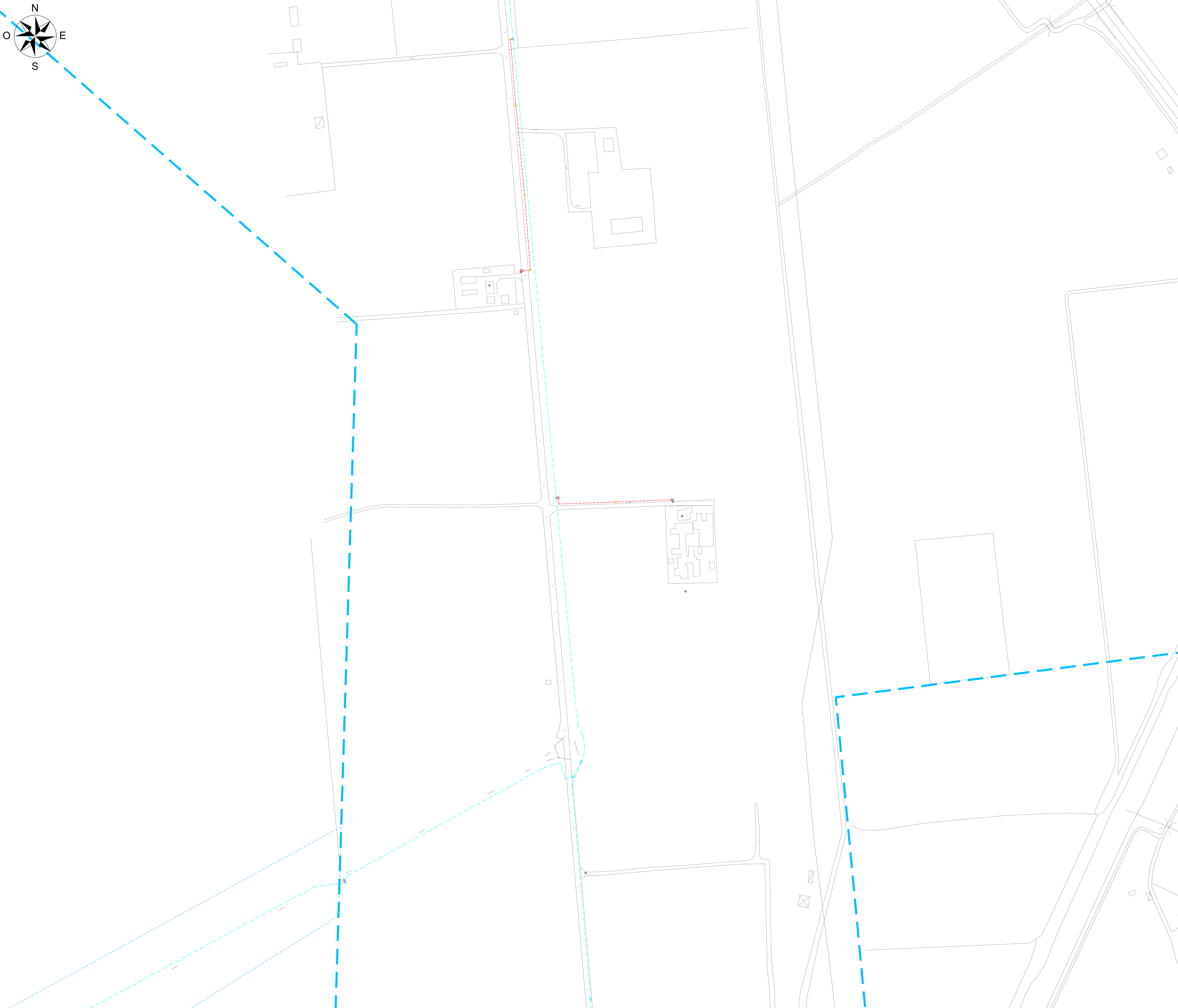

**REALIZZAZIONE, POSA IN OPERA E SERVIZIO DI MANUTENZIONE
DI IMPIANTI IN FIBRA OTTICA**



Comune di PISA
Via degli Uffizi, 1
56100 Pisa (PI)
comune.pisa@postacert.toscana.it

COMMITTENTE



REGIONAL MANAGER
REGIONE TOSCANA
MARCO GASPARIANI

PROGETTISTA



ISTANZA DI AUTORIZZAZIONE

ELABORATO		PLANIMETRIA SCAVI DETTAGLIO COMUNE DI PISA AREA_EST_PISA		DATA	
REDAITTO		VERIFICATO		DATA	19/06/2023
APPROVATO		AGGIORNAMENTI		SCALA	1:2000
REVISIONE	DATA	AGGIORNAMENTI		NOME FILE	PISA-PL-S-EST-10
1.0	19/06/2023	-		CODICE PROGETTO	FISA
1.1	-	-		FINANZIATO	
1.2	-	-		TAVOLA	6

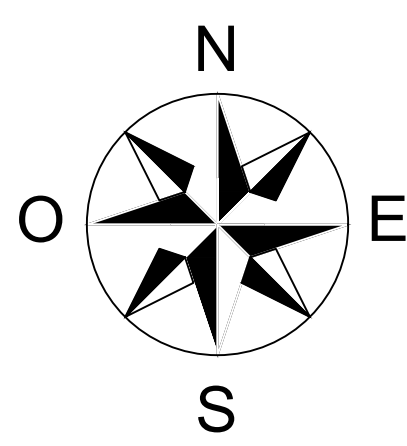

LEGENDA CIVILE

-  VINCOLO IDROGEOLOGICO
REGIO DECRETO 3267/1923
-  TRINCEA TRADIZIONALE
-  MINITRINCEA
-  MICROTRINCEA
-  NO-DIG
-  CANALETTA EOF
-  RETE ED ESISTENTE AEREA
-  RETE ALTRI ESISTENTE AEREA
-  RETE ESISTENTE IP INTERRATA
-  RETE ESISTENTE INTERRATA
-  AREA PPP
-  AREA PFS
-  POZZETTO 76x40
-  POZZETTO 125x80
-  POZZETTO 90x70
-  POZZETTO 40x15
-  POZZETTO 45x45
-  POZZETTI TERZI ESISTENTI
-  COLONNINA PFS-ARMADIO
-  RFI-RETE FERROVIARIE DELLO STATO
-  SS-STRADA STATALE-ANAS
-  SP-STRADA PROVINCIALE



**REALIZZAZIONE, POSA IN OPERA E SERVIZIO DI MANUTENZIONE
DI IMPIANTI IN FIBRA OTTICA**



Comune di PISA
Via degli Uffizi, 1
56100 Pisa (PI)
comune.pisa@postacert.toscana.it

COMMITTENTE



REGIONAL MANAGER
REGIONE TOSCANA
MARCO GASPARINI

PROGETTISTA



ISTANZA DI AUTORIZZAZIONE

ELABORATO		DATA	
PLANIMETRIA SCAVI DETTAGLIO COMUNE DI PISA AREA_EST_PISA		REDAITTO	DATA
VERIFICATO		VERIFICATO	DATA
APPROVATO		APPROVATO	DATA
1.0	19/06/2023	-	19/06/2023
1.1	-	-	-
1.2	-	-	-
		SCALA	CODICE PROGETTO
		1:2000	PISA FINANZIATO
		NOME FILE	TAVOLA
		PISA-PL-S-EST-10	7

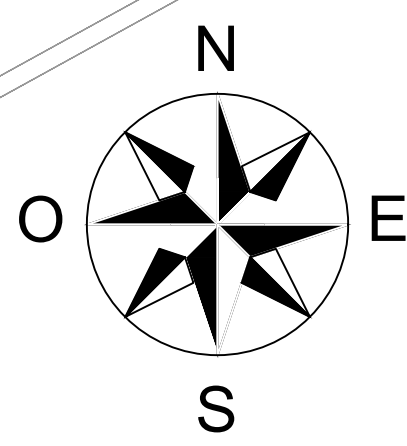

LEGENDA CIVILE

- VINCOLO IDROGEOLOGICO
REGIO DECRETO 3267/1923
- TRINCEA TRADIZIONALE
- MINITRINCEA
- MICROTRINCEA
- NO-DIG
- CANALETTA EOF
- RETE ED ESISTENTE AEREA
- RETE ALTRI ESISTENTE AEREA
- RETE ESISTENTE IP INTERRATA
- RETE ESISTENTE INTERRATA
- AREA PPP
- AREA PFS
- POZZETTO 76x40
- POZZETTO 125x80
- POZZETTO 90x70
- POZZETTO 48x15
- POZZETTO 45x45
- POZZETTI TERZI ESISTENTI
- COLONNINA PFS-ARMADIO
- RFI-RETE FERROVIARIE DELLO STATO
- SS-STRADA STATALE-ANAS
- SP-STRADA PROVINCIALE

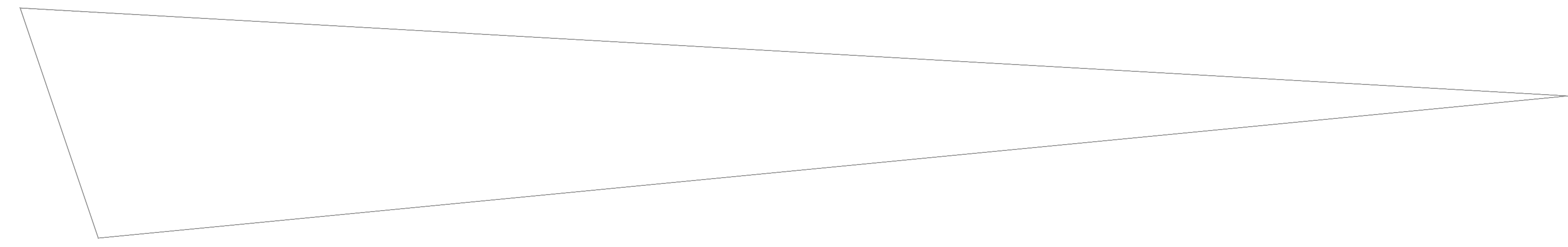

**REALIZZAZIONE, POSA IN OPERA E SERVIZIO DI MANUTENZIONE
DI IMPIANTI IN FIBRA OTTICA**



Comune di PISA
Via degli Uffizi, 1
56100 Pisa (PI)
comune.pisa@postacert.toscana.it

COMMITTENTE



REGIONAL MANAGER
REGIONE TOSCANA
MARCO GASPARIANI

PROGETTISTA







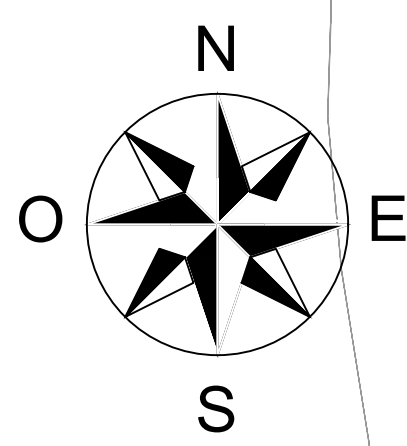





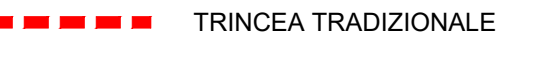

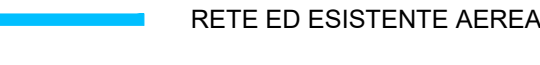

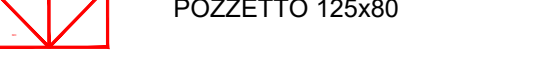

ISTANZA DI AUTORIZZAZIONE

ELABORATO		DATA	
PLANIMETRIA SCAVI DETTAGLIO COMUNE DI PISA AREA_EST_PISA			
	REDAITTO		
	VERIFICATO		
	APPROVATO		
	DATA	19/06/2023	CODICE PROGETTO FISA
REVISIONE	DATA	AGGIORNAMENTI	SCALA
1.0	19/06/2023	-	1:2000
1.1	-	-	NOME FILE
1.2	-	-	PISA-PL-S-EST-10
			TAVOLA 8



CASCINE VECCHIE

LEGENDA CIVILE

-  VINCOLO IDROGEOLOGICO
REGIO DECRETO 3267/1923
-  TRINCEA TRADIZIONALE
-  MINITRINCEA
-  MICROTRINCEA
-  NO-DIG
-  CANALETTA EOF
-  RETE ED ESISTENTE AEREA
-  RETE ALTRI ESISTENTE AEREA
-  RETE ESISTENTE IP INTERRATA
-  RETE ESISTENTE INTERRATA
-  AREA PPP
-  AREA PFS
-  POZZETTO 76x40
-  POZZETTO 125x80
-  POZZETTO 90x70
-  POZZETTO 40x15
-  POZZETTO 45x45
-  POZZETTI TERZI ESISTENTI
-  COLONNINA PFS-ARMADIO
-  RFI-RETE FERROVIARIE DELLO STATO
-  SS-STRADA STATALE-ANAS
-  SP-STRADA PROVINCIALE

REALIZZAZIONE, POSA IN OPERA E SERVIZIO DI MANUTENZIONE
DI IMPIANTI IN FIBRA OTTICA



Comune di PISA
Via degli Uffizi, 1
56100 Pisa (PI)
comune.pisa@postacert.toscana.it

COMMITTENTE: **open fiber**
REGIONAL MANAGER
REGIONE TOSCANA
MARCO GASPARINI

PROGETTISTA: **accenture**

ISTANZA DI AUTORIZZAZIONE

ELABORATO		PLANIMETRIA SCAVI DETTAGLIO COMUNE DI PISA AREA_EST_PISA		DATA	
REVISIONE	DATA	AGGIORNAMENTI	SCALA	1:2000	TAVOLA
1.0	19/06/2023	-	NOME FILE	PISA-PL-S-EST-10	9
1.1	-	-			
1.2	-	-			

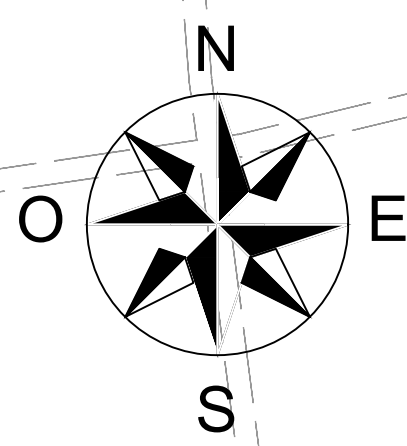

LEGENDA CIVILE

- VINCOLO IDROGEOLOGICO
REGIO DECRETO 3267/1923
- TRINCEA TRADIZIONALE
- MINITRINCEA
- MICROTRINCEA
- NO-DIG
- CANALETTA EOF
- RETE ED ESISTENTE AEREA
- RETE ALTRI ESISTENTE AEREA
- RETE ESISTENTE IP INTERRATA
- RETE ESISTENTE INTERRATA
- AREA PPP
- AREA PFS
- POZZETTO 76x40
- POZZETTO 125x80
- POZZETTO 90x70
- POZZETTO 48x15
- POZZETTO 45x45
- POZZETTI TERZI ESISTENTI
- COLONNINA PFS-ARMADIO
- RFI-RETE FERROVIARIE DELLO STATO
- SS-STRADA STATALE-ANAS
- SP-STRADA PROVINCIALE

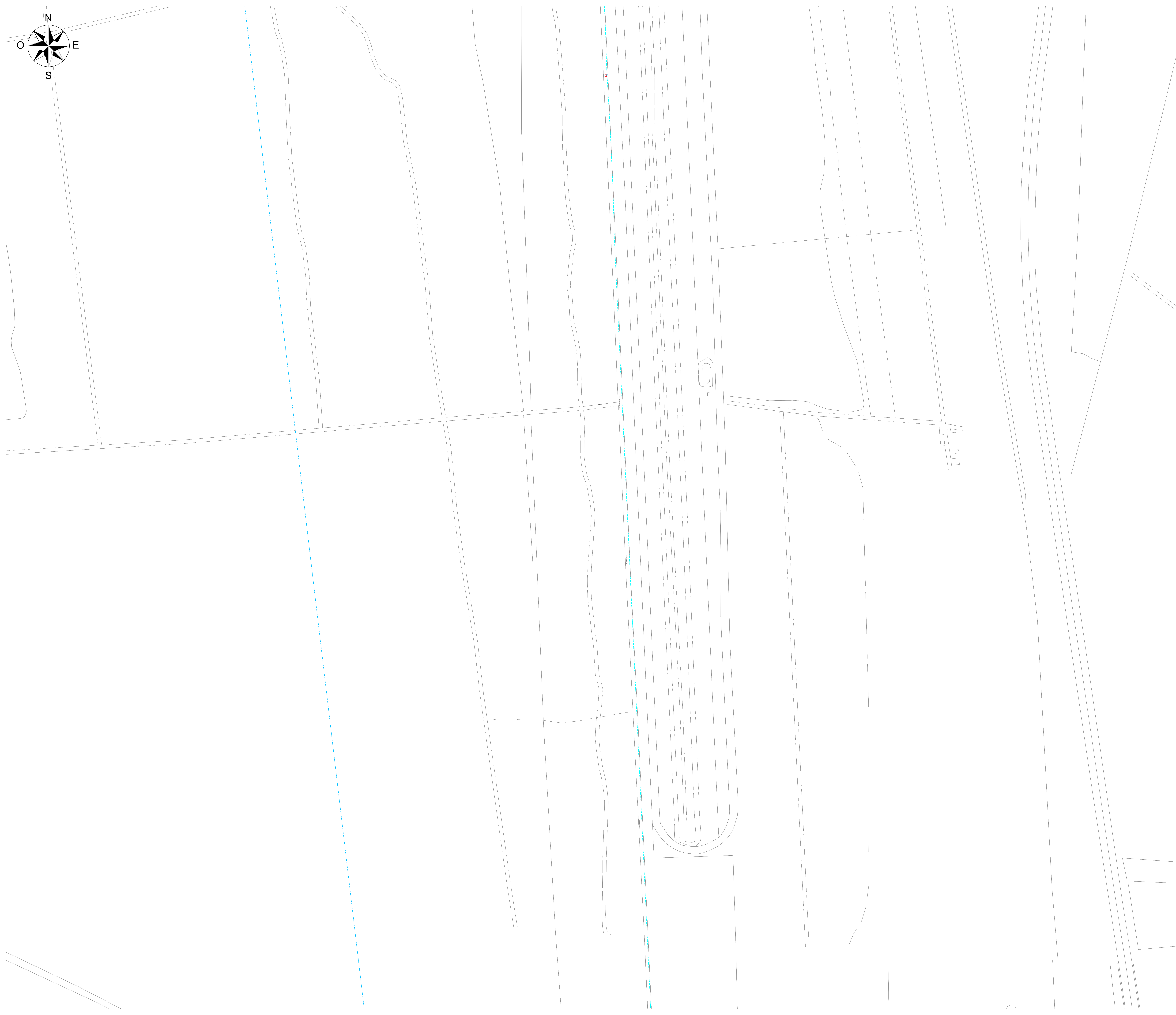

**REALIZZAZIONE, POSA IN OPERA E SERVIZIO DI MANUTENZIONE
DI IMPIANTI IN FIBRA OTTICA**

Comune di PISA
Via degli Uffizi, 1
56100 Pisa (PI)
comune.pisa@postacert.toscana.it

COMMITTENTE

REGIONAL MANAGER
REGIONE TOSCANA
MARCO GASPARINI







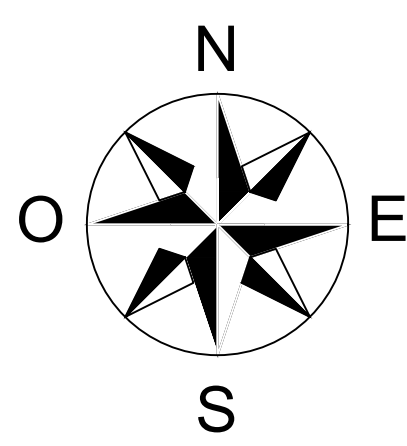





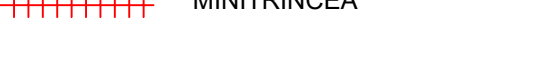





PROGETTISTA

ISTANZA DI AUTORIZZAZIONE

ELABORATO		DATA	
PLANIMETRIA SCAVI DETTAGLIO COMUNE DI PISA AREA_EST_PISA			
REDAITTO		VERIFICATO	
APPROVATO		DATA	19/06/2023
REVISIONE	DATA	AGGIORNAMENTI	SCALA
1.0	19/06/2023	-	1:2000
1.1	-	-	NOME FILE
1.2	-	-	PISA-PL-S-EST-10
			CODICE PROGETTO PISA FINANZIATO
			TAVOLA



LEGENDA CIVILE

-  VINCOLO IDROGEOLOGICO
REGIO DECRETO 3267/1923
-  TRINCEA TRADIZIONALE
-  MINITRINCEA
-  MICROTRINCEA
-  NO-DIG
-  CANALETTA EOF
-  RETE ED ESISTENTE AEREA
-  RETE ALTRI ESISTENTE AEREA
-  RETE ESISTENTE IP INTERRATA
-  RETE ESISTENTE INTERRATA
-  AREA PPP
-  AREA PFS
-  POZZETTO 76x40
-  POZZETTO 125x80
-  POZZETTO 90x70
-  POZZETTO 48x15
-  POZZETTO 45x45
-  POZZETTI TERZI ESISTENTI
-  COLONNINA PFS-ARMADIO
-  RFI-RETE FERROVIARIE DELLO STATO
-  SS-STRADA STATALE-ANAS
-  SP-STRADA PROVINCIALE

CASCINE NUOVE

**REALIZZAZIONE, POSA IN OPERA E SERVIZIO DI MANUTENZIONE
DI IMPIANTI IN FIBRA OTTICA**



Comune di PISA
Via degli Uffizi, 1
56100 Pisa (PI)
comune.pisa@postacert.toscana.it

COMMITTENTE



REGIONAL MANAGER
REGIONE TOSCANA
MARCO GASPARINI

PROGETTISTA



ISTANZA DI AUTORIZZAZIONE			
ELABORATO	PLANIMETRIA SCAVI DETTAGLIO COMUNE DI PISA AREA_EST_PISA	DATA	
		REDAITTO	
		VERIFICATO	
		APPROVATO	
		DATA	19/06/2023
		CODICE PROGETTO	PISA
REVISIONE	DATA	AGGIORNAMENTI	SCALA
1.0	19/06/2023	-	1:2000
1.1	-	-	NOME FILE
1.2	-	-	PISA-PL-S-EST-10
			TAVOLA 11

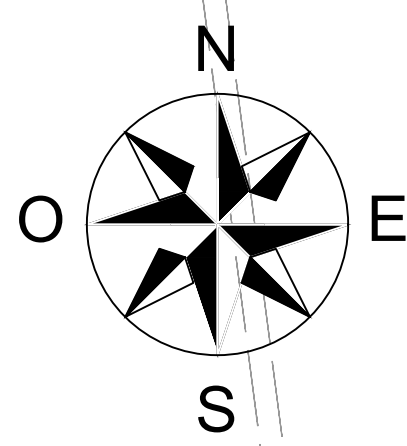

LEGENDA CIVILE

- VINCOLO IDROGEOLOGICO
REGIO DECRETO 3267/1923
- TRINCEA TRADIZIONALE
- MINITRINCEA
- MICROTRINCEA
- NO-DIG
- CANALETTA EOF
- RETE ED ESISTENTE AEREA
- RETE ALTRI ESISTENTE AEREA
- RETE ESISTENTE IP INTERRATA
- RETE ESISTENTE INTERRATA
- AREA PPP
- AREA PFS
- POZZETTO 76x40
- POZZETTO 125x80
- POZZETTO 90x70
- POZZETTO 40x15
- POZZETTO 45x45
- POZZETTI TERZI ESISTENTI
- COLONNINA PFS-ARMADIO
- RFI-RETE FERROVIARIE DELLO STATO
- SS-STRADA STATALE-ANAS
- SP-STRADA PROVINCIALE

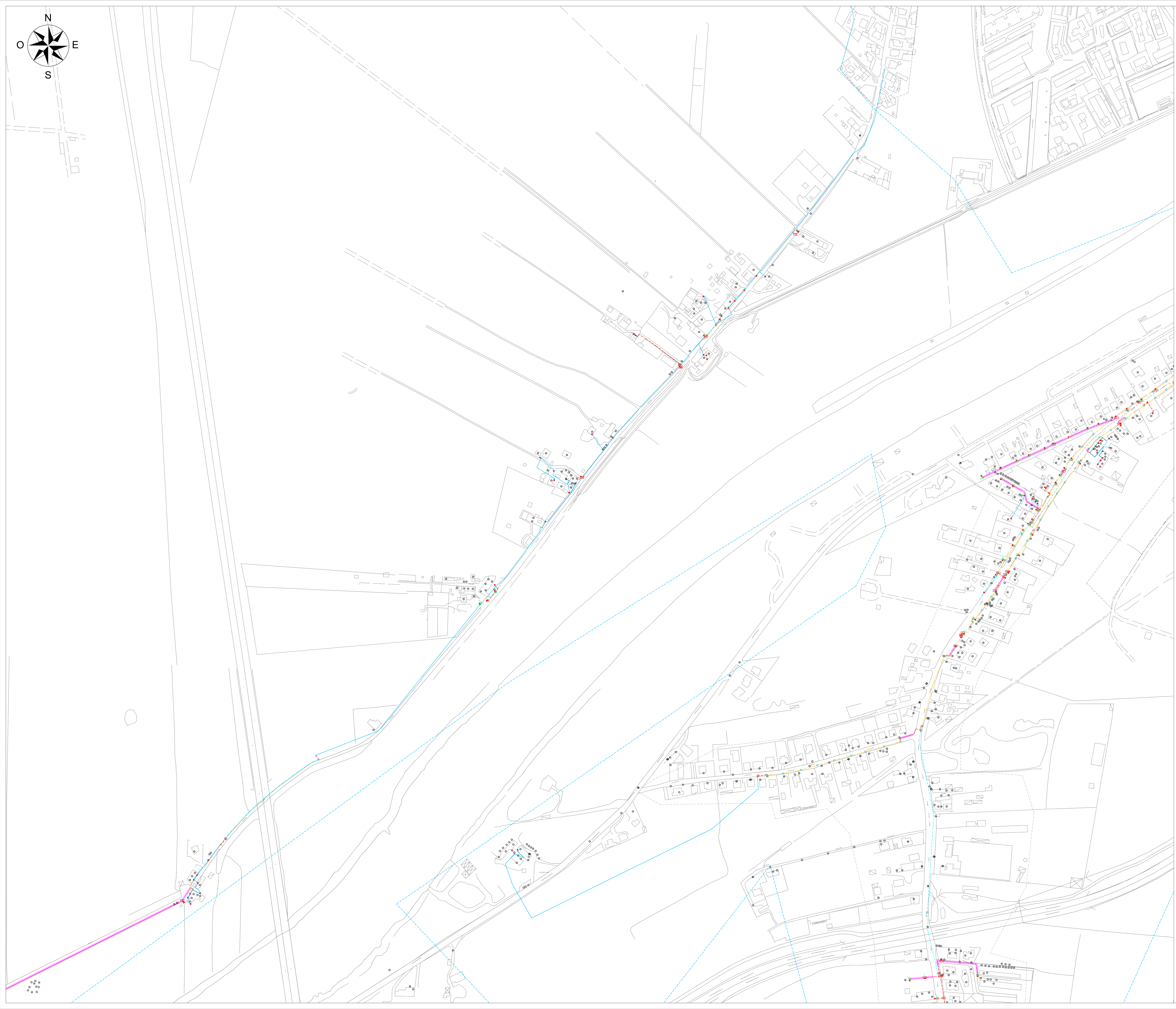

**REALIZZAZIONE, POSA IN OPERA E SERVIZIO DI MANUTENZIONE
DI IMPIANTI IN FIBRA OTTICA**



Comune di PISA
Via degli Uffizi, 1
56100 Pisa (PI)
comune.pisa@postacert.toscana.it

COMMITTENTE



REGIONAL MANAGER
REGIONE TOSCANA
MARCO GASPARINI

PROGETTISTA



ISTANZA DI AUTORIZZAZIONE

ELABORATO		DATA	
PLANIMETRIA SCAVI DETTAGLIO COMUNE DI PISA AREA_EST_PISA		REDAITTO	DATA
VERIFICATO		VERIFICATO	DATA
APPROVATO		APPROVATO	DATA
1.0		19/06/2023	19/06/2023
1.1		-	-
1.2		-	-
AGGIORNAMENTI		SCALA	CODICE PROGETTO
-		1:2000	PISA FINANZIATO
NOME FILE		TAVOLA	
PISA-PL-S-EST-10		12	

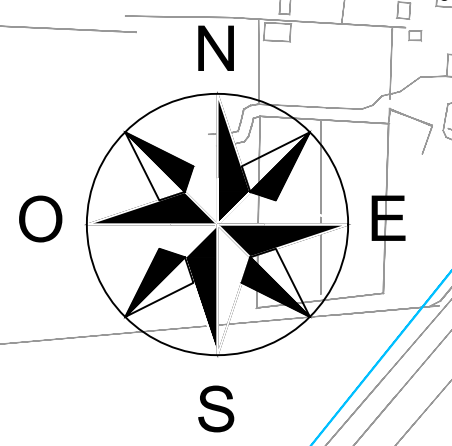

LEGENDA CIVILE

-  VINCOLO IDROGEOLOGICO
REGIO DECRETO 3267/1923
-  TRINCEA TRADIZIONALE
-  MINITRINCEA
-  MICROTRINCEA
-  NO-DIG
-  CANALETTA EOF
-  RETE ED ESISTENTE AEREA
-  RETE ALTRI ESISTENTE AEREA
-  RETE ESISTENTE IP INTERRATA
-  RETE ESISTENTE INTERRATA
-  AREA PFP
-  AREA PFS
-  POZZETTO 76x40
-  POZZETTO 125x80
-  POZZETTO 90x70
-  POZZETTO 40x15
-  POZZETTO 45x45
-  POZZETTI TERZI ESISTENTI
-  COLONNINA PFS-ARMADIO
-  RFI-RETE FERROVIARIE DELLO STATO
-  SS-STRADA STATALE-ANAS
-  SP-STRADA PROVINCIALE

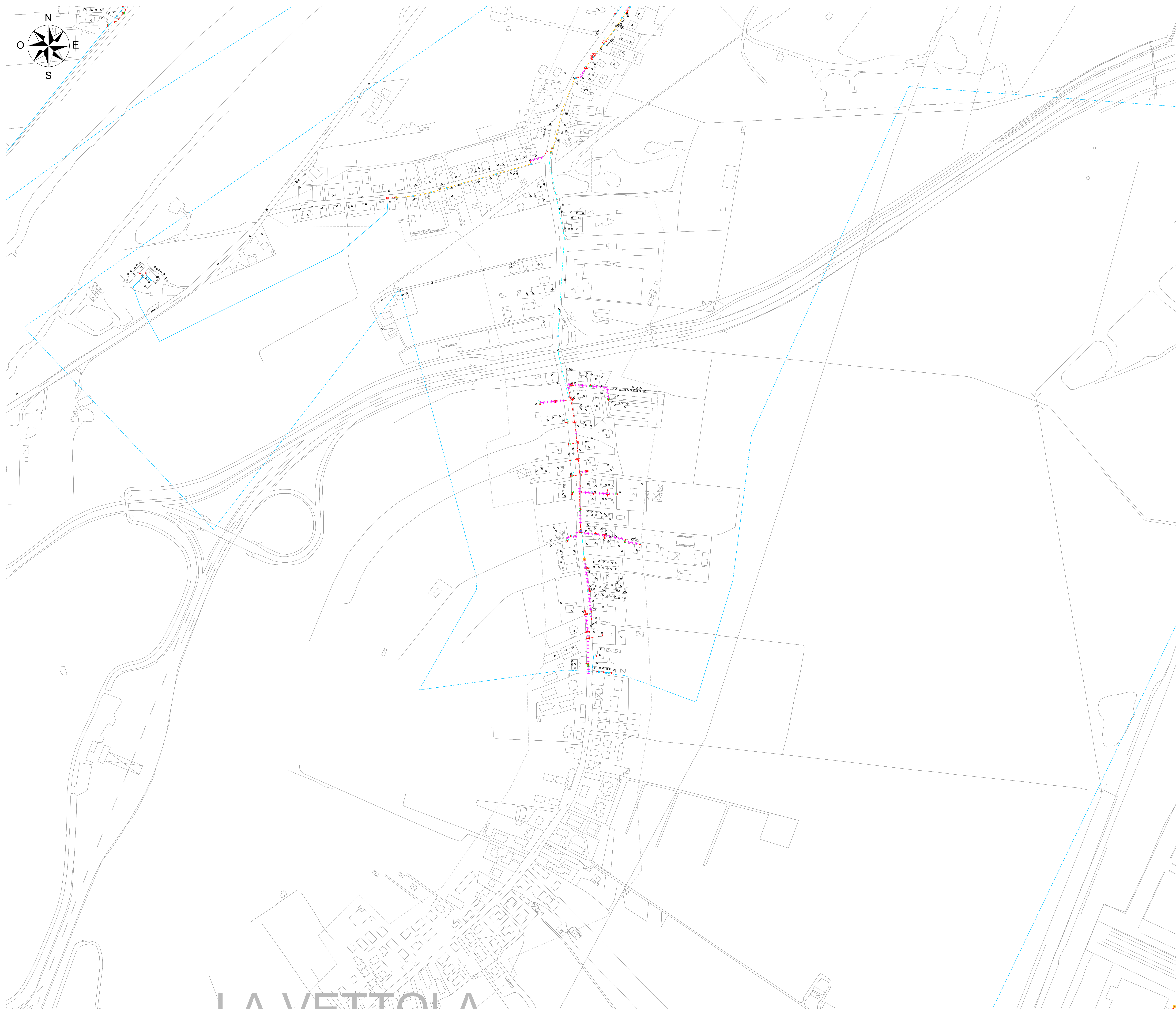

REALIZZAZIONE, POSA IN OPERA E SERVIZIO DI MANUTENZIONE
DI IMPIANTI IN FIBRA OTTICA



Comune di PISA
Via degli Uffizi, 1
56100 Pisa (PI)
comune.pisa@postacert.toscana.it

COMMITTENTE:  REGIONAL MANAGER
REGIONE TOSCANA
MARCO GASPARINI

PROGETTISTA: 

ISTANZA DI AUTORIZZAZIONE

ELABORATO		PLANIMETRIA SCAVI DETTAGLIO COMUNE DI PISA AREA_EST_PISA		DATA	
REVISIONE	DATA	AGGIORNAMENTI	SCALA	1:2000	TAVOLA
1.0	19/06/2023	-	NOME FILE	PISA-PL-S-EST-10	13
1.1	-	-			
1.2	-	-			

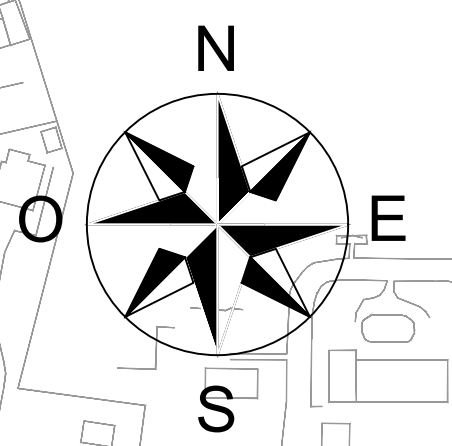
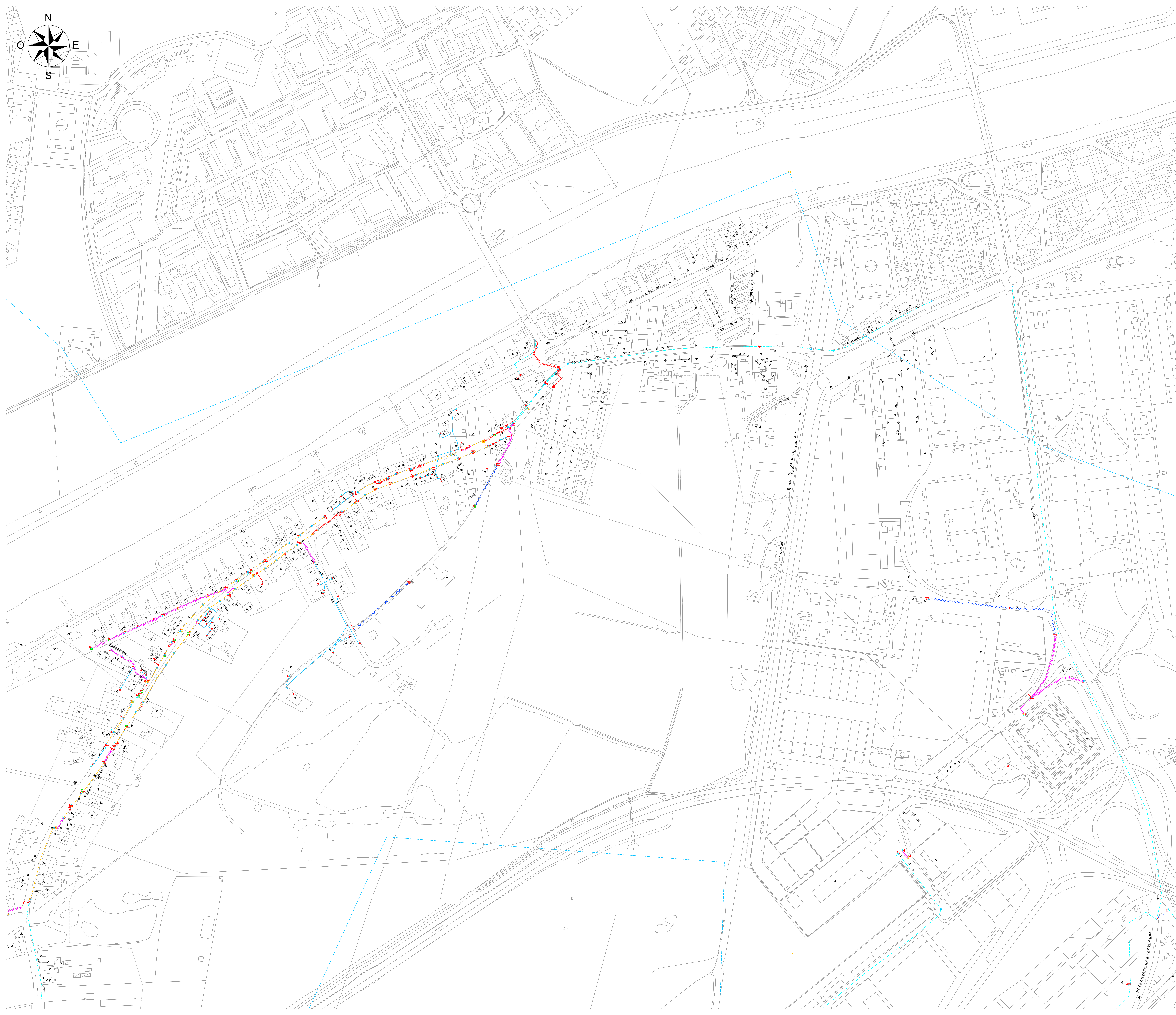

LEGENDA CIVILE

- VINCOLO IDROGEOLOGICO REGIO DECRETO 3267/1923
- TRINCEA TRADIZIONALE
- MINITRINCEA
- MICROTINCEA
- NO-DIG
- CANALETTA EOF
- RETE ED ESISTENTE AEREA
- RETE ALTRI ESISTENTE AEREA
- RETE ESISTENTE IP INTERRATA
- RETE ESISTENTE INTERRATA
- AREA PPP
- AREA PFS
- POZZETTO 76x40
- POZZETTO 125x80
- POZZETTO 90x70
- POZZETTO 40x15
- POZZETTO 45x45
- POZZETTI TERZI ESISTENTI
- COLONNINA PFS-ARMADIO
- RFI-RETE FERROVIARIE DELLO STATO
- SS-STRADA STATALE-ANAS
- SP-STRADA PROVINCIALE

REALIZZAZIONE, POSA IN OPERA E SERVIZIO DI MANUTENZIONE
DI IMPIANTI IN FIBRA OTTICA



Comune di PISA
Via degli Uffizi, 1
56100 Pisa (PI)
comune.pisa@postacert.toscana.it

COMMITTENTE: **open fiber** REGIONAL MANAGER REGIONE TOSCANA MARCO GASPARINI

PROGETTISTA: **accenture**

ISTANZA DI AUTORIZZAZIONE

ELABORATO: PLANIMETRIA SCAVI DETTAGLIO COMUNE DI PISA AREA_EST_PISA			DATA	
			REDAITTO	
REVISIONE DATA AGGIORNAMENTI			VERIFICATO	
			APPROVATO	
1.0	19/06/2023	-	DATA: 19/06/2023	CODICE PROGETTO: PISA
1.1	-	-	SCALA: 1:2000	FINANZIATO: PISA
1.2	-	-	NOME FILE: PISA-PL-S-EST-10	TAVOLA: 14

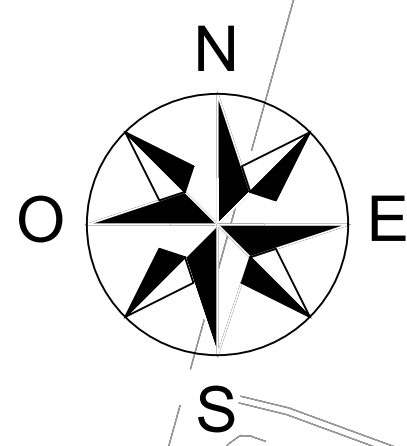

LEGENDA CIVILE

-  VINCOLO IDROGEOLOGICO
REGIO DECRETO 3267/1923
-  TRINCEA TRADIZIONALE
-  MINITRINCEA
-  MICROTRINCEA
-  NO-DIG
-  CANALETTA EOF
-  RETE ED ESISTENTE AEREA
-  RETE ALTRI ESISTENTE AEREA
-  RETE ESISTENTE IP INTERRATA
-  RETE ESISTENTE INTERRATA
-  AREA PFP
-  AREA PFS
-  POZZETTO 76x40
-  POZZETTO 125x80
-  POZZETTO 90x70
-  POZZETTO 40x15
-  POZZETTO 45x45
-  POZZETTI TERZI ESISTENTI
-  COLONNINA PFS-ARMADIO
-  RFI-RETE FERROVIARIE DELLO STATO
-  SS-STRADA STATALE-ANAS
-  SP-STRADA PROVINCIALE

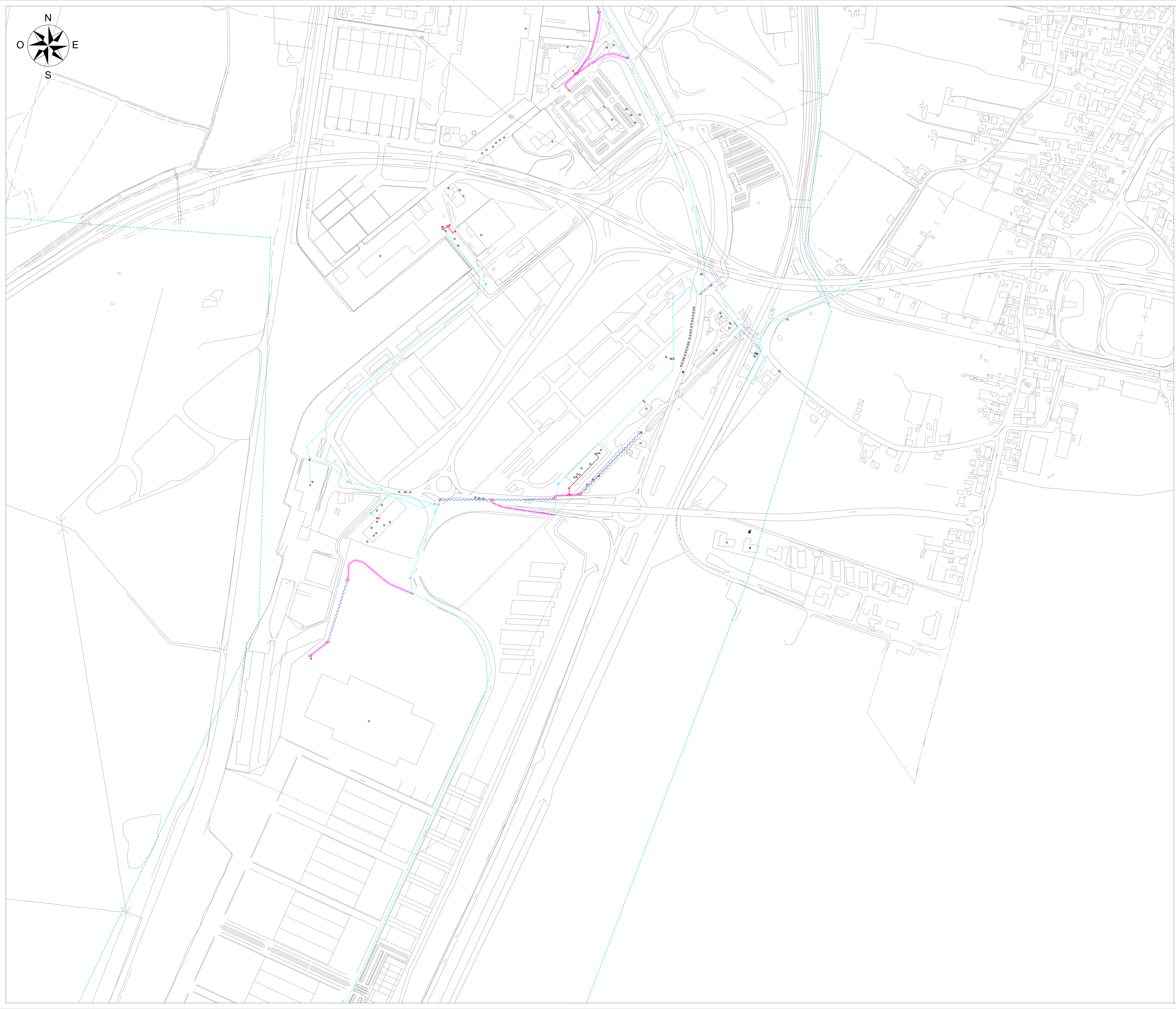

REALIZZAZIONE, POSA IN OPERA E SERVIZIO DI MANUTENZIONE
DI IMPIANTI IN FIBRA OTTICA



Comune di PISA
Via degli Uffizi, 1
56100 Pisa (PI)
comune.pisa@postacert.toscana.it

COMMITTENTE:  REGIONAL MANAGER
REGIONE TOSCANA
MARCO GASPARINI

PROGETTISTA: 

ISTANZA DI AUTORIZZAZIONE

ELABORATO		PLANIMETRIA SCAVI DETTAGLIO COMUNE DI PISA AREA_EST_PISA		DATA	
REVISIONE	DATA	AGGIORNAMENTI	SCALA	1:2000	TAVOLA
1.0	19/06/2023	-			
1.1	-	-	NOME FILE		
1.2	-	-	PISA-PL-S-EST-10		



LEGENDA CIVILE

-  VINCOLO IDROGEOLOGICO
REGIO DECRETO 3267/1923
-  TRINCEA TRADIZIONALE
-  MINITRINCEA
-  MICROTRINCEA
-  NO-DIG
-  CANALETTA EOF
-  RETE ED ESISTENTE AEREA
-  RETE ALTRI ESISTENTE AEREA
-  RETE ESISTENTE IP INTERRATA
-  RETE ESISTENTE INTERRATA
-  AREA PPP
-  AREA PFS
-  POZZETTO 76x40
-  POZZETTO 125x80
-  POZZETTO 90x70
-  POZZETTO 40x15
-  POZZETTO 45x45
-  POZZETTI TERZI ESISTENTI
-  COLONNINA PFS-ARMADIO
-  RFI-RETE FERROVIARIE DELLO STATO
-  SS-STRADA STATALE-ANAS
-  SP-STRADA PROVINCIALE

REALIZZAZIONE, POSA IN OPERA E SERVIZIO DI MANUTENZIONE
DI IMPIANTI IN FIBRA OTTICA



Comune di PISA
Via degli Uffizi, 1
56100 Pisa (PI)
comune.pisa@postacert.toscana.it

COMMITTENTE: **open fiber** REGIONAL MANAGER REGIONE TOSCANA MARCO GASPARINI

PROGETTISTA: **accenture**

ISTANZA DI AUTORIZZAZIONE

ELABORATO		PLANIMETRIA SCAVI DETTAGLIO COMUNE DI PISA AREA_EST_PISA		DATA	
REVISIONE	DATA	AGGIORNAMENTI	SCALA	1:2000	TAVOLA
1.0	19/06/2023	-	NOME FILE	PISA-PL-S-EST-10	16
1.1	-	-			
1.2	-	-			

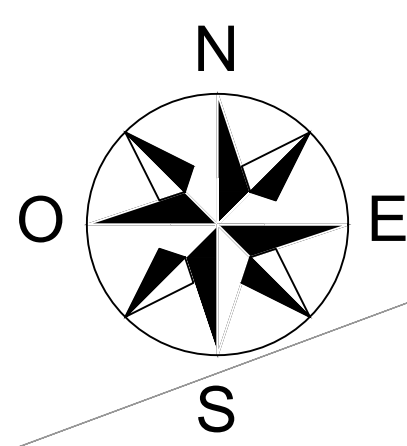

LEGENDA CIVILE

-  VINCOLO IDROGEOLOGICO
REGIO DECRETO 3267/1923
-  TRINCEA TRADIZIONALE
-  MINITRINCEA
-  MICROTRINCEA
-  NO-DIG
-  CANALETTA EOF
-  RETE ED ESISTENTE AEREA
-  RETE ALTRI ESISTENTE AEREA
-  RETE ESISTENTE IP INTERRATA
-  RETE ESISTENTE INTERRATA
-  AREA PPP
-  AREA PFS
-  POZZETTO 76x40
-  POZZETTO 125x80
-  POZZETTO 90x70
-  POZZETTO 48x15
-  POZZETTO 45x45
-  POZZETTI TERZI ESISTENTI
-  COLONNINA PFS-ARMADIO
-  RFI-RETE FERROVIARIE DELLO STATO
-  SS-STRADA STATALE-ANAS
-  SP-STRADA PROVINCIALE

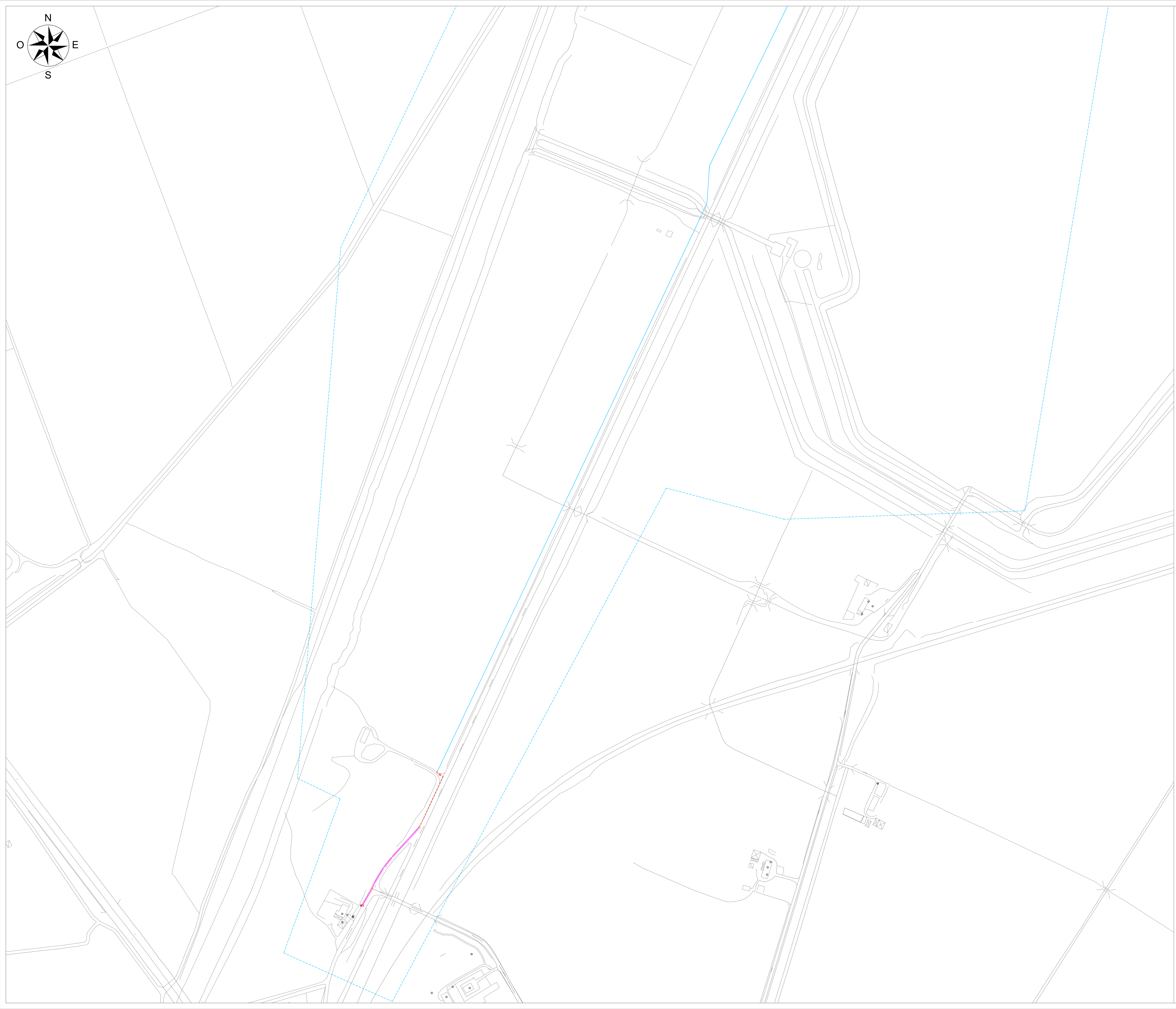

**REALIZZAZIONE, POSA IN OPERA E SERVIZIO DI MANUTENZIONE
DI IMPIANTI IN FIBRA OTTICA**



Comune di PISA
Via degli Uffizi, 1
56100 Pisa (PI)
comune.pisa@postacert.toscana.it

<p>COMMITTENTE</p>  <p>REGIONAL MANAGER REGIONE TOSCANA MARCO GASPARINI</p>	<p>PROGETTISTA</p> 
--	--

ISTANZA DI AUTORIZZAZIONE

ELABORATO		PLANIMETRIA SCAVI DETTAGLIO COMUNE DI PISA AREA_EST_PISA		DATA	19/06/2023	CODICE PROGETTO PISA FINANZIATO
REVISIONE	DATA	AGGIORNAMENTI	SCALA	1:2000	TAVOLA	17
1.0	19/06/2023	-	NOME FILE	PISA-PL-S-EST-10		
1.1	-	-				
1.2	-	-				

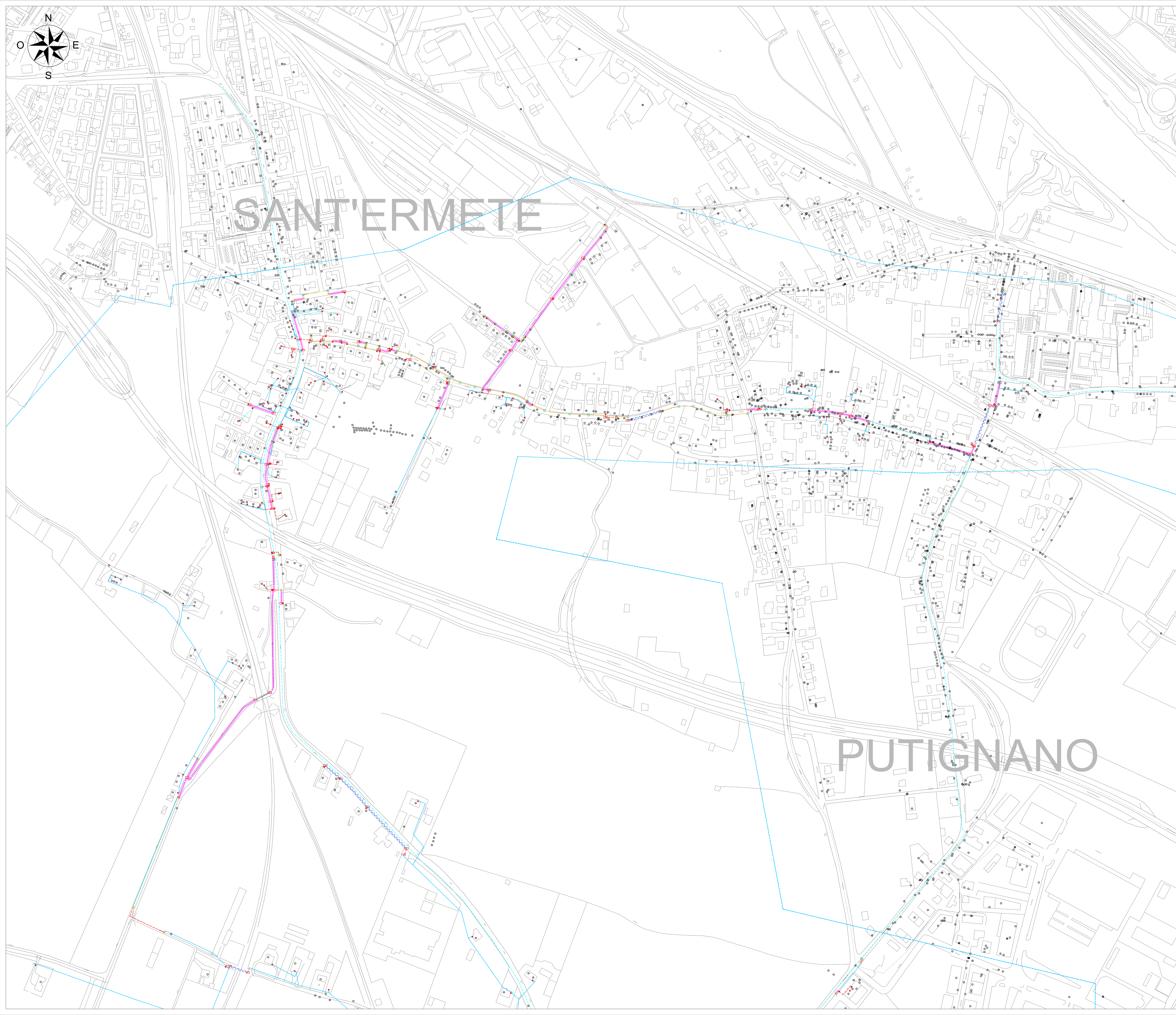

LEGENDA CIVILE

- VINCOLO IDROGEOLOGICO REGIO DECRETO 3267/1923
- TRINCEA TRADIZIONALE
- MINITRINCEA
- MICROTRINCEA
- NO-DIG
- CANALETTA EOF
- RETE ED ESISTENTE AEREA
- RETE ALTRI ESISTENTE AEREA
- RETE ESISTENTE IP INTERRUATA
- RETE ESISTENTE INTERRUATA
- AREA PPP
- AREA PFS
- POZZETTO 76x40
- POZZETTO 125x80
- POZZETTO 90x70
- POZZETTO 48x15
- POZZETTO 45x45
- POZZETTI TERZI ESISTENTI
- COLONNINA PFS-ARMADIO
- RFI-RETE FERROVIARIE DELLO STATO
- SS-STRADE STATALI-ANAS
- SP-STRADE PROVINCIALI

SANT'ERMETE

PUTIGNANO

REALIZZAZIONE, POSA IN OPERA E SERVIZIO DI MANUTENZIONE
DI IMPIANTI IN FIBRA OTTICA

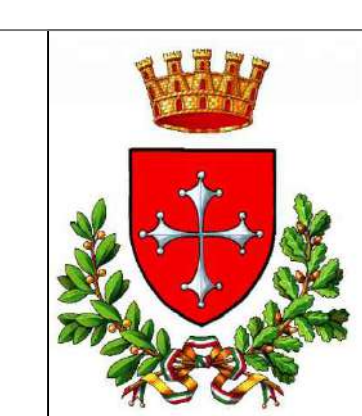

Comune di PISA
Via degli Uffizi, 1
56100 Pisa (PI)
comune.pisa@postacert.toscana.it

COMMITTENTE: **open fiber** REGIONAL MANAGER REGIONE TOSCANA MARCO GASPARINI

PROGETTISTA: **accenture**

ISTANZA DI AUTORIZZAZIONE

ELABORATO: PLANIMETRIA SCAVI DETTAGLIO COMUNE DI PISA AREA_EST_PISA			DATA: 19/06/2023		
REVISIONE	DATA	AGGIORNAMENTI	SCALA	CODICE PROGETTO	PIVA FINANZIATO
1.0	19/06/2023	-	1:2000		
1.1	-	-	NOME FILE		
1.2	-	-	PISA-PL-S-EST-10		

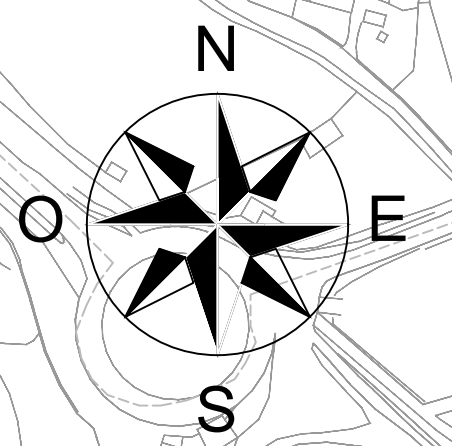
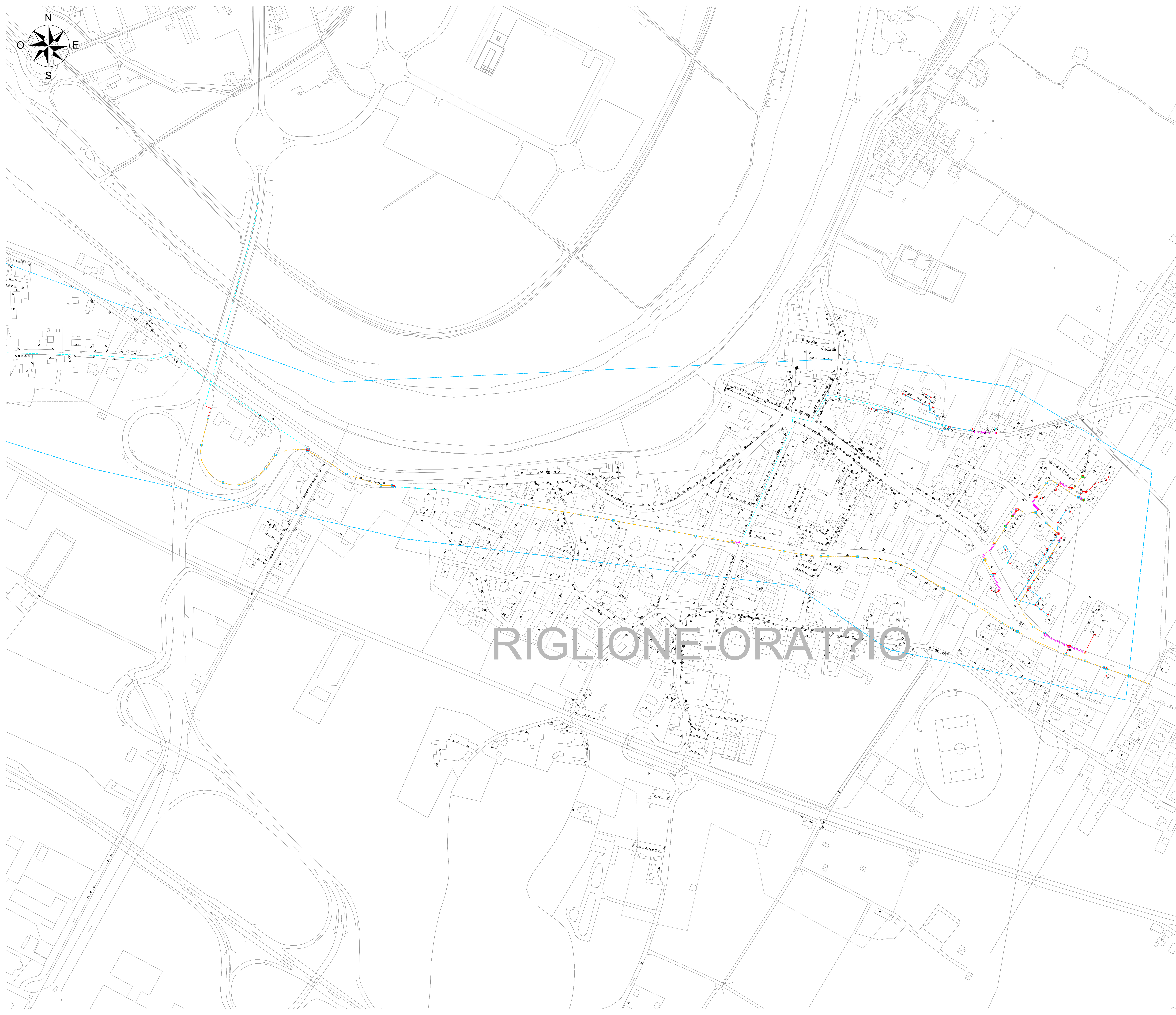

LEGENDA CIVILE

- VINCOLO IDROGEOLOGICO REGIO DECRETO 3267/1923
- TRINCEA TRADIZIONALE
- MINITRINCEA
- MICROTRINCEA
- NO-DIG
- CANALETTA EOF
- RETE ED ESISTENTE AEREA
- RETE ALTRI ESISTENTE AEREA
- RETE ESISTENTE IP INTERRATA
- RETE ESISTENTE INTERRATA
- AREA PPP
- AREA PFS
- POZZETTO 76x40
- POZZETTO 125x80
- POZZETTO 90x70
- POZZETTO 40x15
- POZZETTO 45x45
- POZZETTI TERZI ESISTENTI
- COLONNINA PFS-ARMADIO
- RFI-RETE FERROVIARIE DELLO STATO
- SS-STRADA STATALE-ANAS
- SP-STRADA PROVINCIALE

RIGLIONE-ORATIO

REALIZZAZIONE, POSA IN OPERA E SERVIZIO DI MANUTENZIONE
DI IMPIANTI IN FIBRA OTTICA

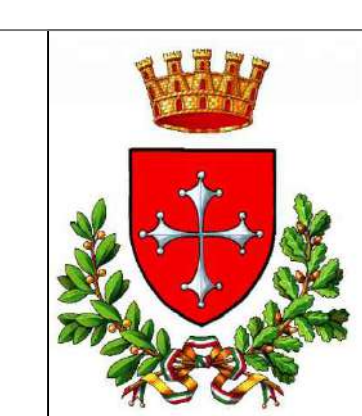

Comune di PISA
Via degli Uffizi, 1
56100 Pisa (PI)
comune.pisa@postacert.toscana.it

COMMITTENTE: **open fiber** REGIONAL MANAGER REGIONE TOSCANA MARCO GASPARINI

PROGETTISTA: **accenture**

ISTANZA DI AUTORIZZAZIONE

ELABORATO			DATA	
PLANIMETRIA SCAVI DETTAGLIO COMUNE DI PISA AREA_EST_PISA			REDAITTO	
			VERIFICATO	
			APPROVATO	
			DATA	19/06/2023
			CODICE PROGETTO	PISA
REVISIONE	DATA	AGGIORNAMENTI	SCALA	FINANZIATO
1.0	19/06/2023	-	1:2000	
1.1	-	-	NOME FILE	TAVOLA
1.2	-	-	PISA-PL-S-EST-10	

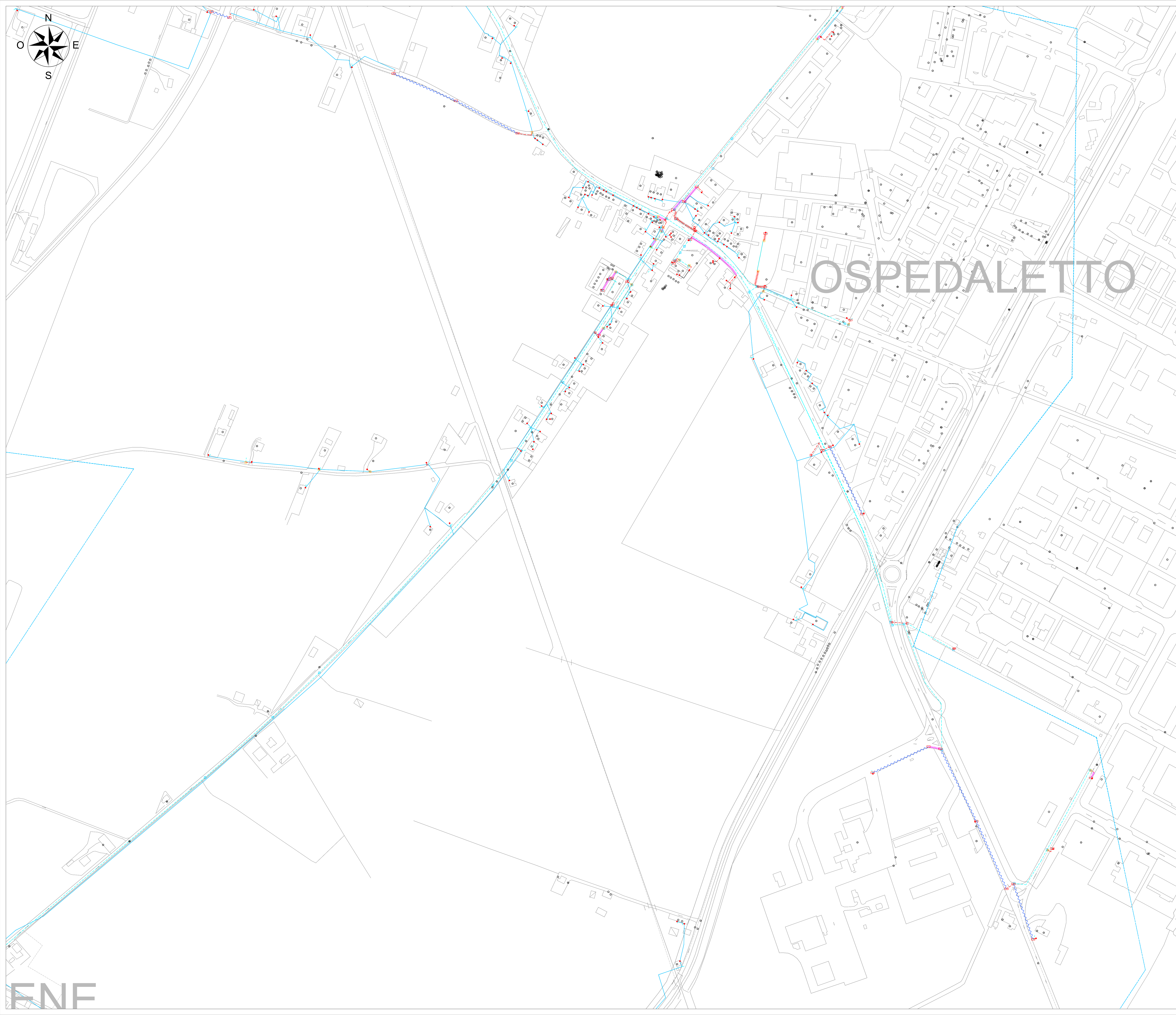

OSPEDALETTO

LEGENDA CIVILE

- VINCOLO IDROGEOLOGICO REGIO DECRETO 3267/1923
- TRINCEA TRADIZIONALE
- MINITRINCEA
- MICROTRINCEA
- NO-DIG
- CANALETTA EOF
- RETE ED ESISTENTE AEREA
- RETE ALTRI ESISTENTE AEREA
- RETE ESISTENTE IP INTERRATA
- RETE ESISTENTE INTERRATA
- AREA PPP
- AREA PFS
- POZZETTO 76x40
- POZZETTO 125x80
- POZZETTO 90x70
- POZZETTO 48x15
- POZZETTO 45x45
- POZZETTI TERZI ESISTENTI
- COLONNINA PFS-ARMADIO
- RFI-RETE FERROVIARIE DELLO STATO
- SS-STRADA STATALE-ANAS
- SP-STRADA PROVINCIALE

REALIZZAZIONE, POSA IN OPERA E SERVIZIO DI MANUTENZIONE
DI IMPIANTI IN FIBRA OTTICA



Comune di PISA
Via degli Uffizi, 1
56100 Pisa (PI)
comune.pisa@postacert.toscana.it

COMMITTENTE
open fiber
REGIONAL MANAGER
REGIONE TOSCANA
MARCO GASPARINI

PROGETTISTA
accenture





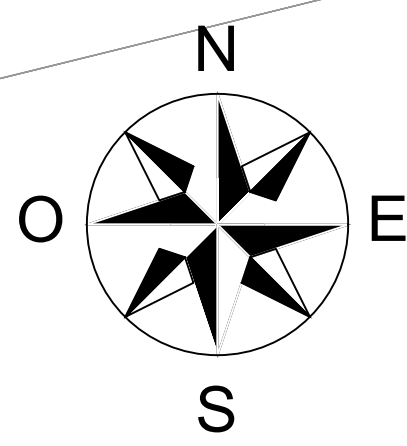





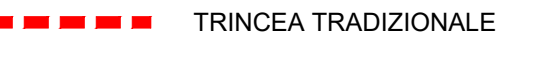

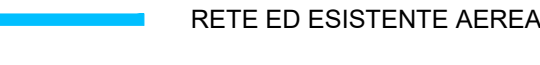

ISTANZA DI AUTORIZZAZIONE

ELABORATO			DATA	
PLANIMETRIA SCAVI DETTAGLIO COMUNE DI PISA AREA_EST_PISA			REDAITTO	
			VERIFICATO	
			APPROVATO	
			DATA	19/06/2023
			CODICE PROGETTO	PISA
REVISIONE	DATA	AGGIORNAMENTI	SCALA	FINANZIATO
1.0	19/06/2023	-	1:2000	PISA
1.1	-	-	NOME FILE	TAVOLA
1.2	-	-	PISA-PL-S-EST-10	20

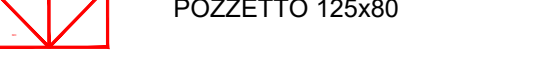

LE RENE

LEGENDA CIVILE

-  VINCOLO IDROGEOLOGICO
REGIO DECRETO 3267/1923
-  TRINCEA TRADIZIONALE
-  MINITRINCEA
-  MICROTRINCEA
-  NO-DIG
-  CANALETTA EOF
-  RETE ED ESISTENTE AEREA
-  RETE ALTRI ESISTENTE AEREA
-  RETE ESISTENTE IP INTERRATA
-  RETE ESISTENTE INTERRATA
-  AREA PPP
-  AREA PFS
-  POZZETTO 76x40
-  POZZETTO 125x80
-  POZZETTO 90x70
-  POZZETTO 40x15
-  POZZETTO 45x45
-  POZZETTI TERZI ESISTENTI
-  COLONNINA PFS-ARMADIO
-  RFI-RETE FERROVIARIE DELLO STATO
-  SS-STRADA STATALE-ANAS
-  SP-STRADA PROVINCIALE

REALIZZAZIONE, POSA IN OPERA E SERVIZIO DI MANUTENZIONE
DI IMPIANTI IN FIBRA OTTICA



Comune di PISA
Via degli Uffizi, 1
56100 Pisa (PI)
comune.pisa@postacert.toscana.it

<p>COMMITTENTE</p>  <p>REGIONAL MANAGER REGIONE TOSCANA MARCO GASPARINI</p>	<p>PROGETTISTA</p> 
--	--

ISTANZA DI AUTORIZZAZIONE

ELABORATO		DATA	
PLANIMETRIA SCAVI DETTAGLIO COMUNE DI PISA AREA_EST_PISA			
		REDAITTO	
		VERIFICATO	
		APPROVATO	
REVISIONE	DATA	AGGIORNAMENTI	SCALA
1.0	19/06/2023	-	1:2000
1.1	-	-	NOME FILE
1.2	-	-	PISA-PL-S-EST-10
		DATA	CODICE PROGETTO
		19/06/2023	PISA
			FINANZIATO
			TAVOLA

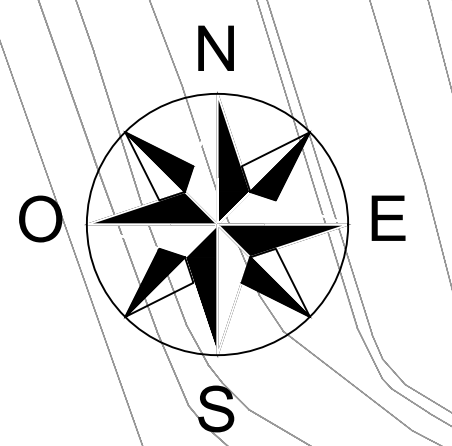

LEGENDA CIVILE

- VINCOLO IDROGEOLOGICO
REGIO DECRETO 3267/1923
- TRINCEA TRADIZIONALE
- MINITRINCEA
- MICROTRINCEA
- NO-DIG
- CANALETTA EOF
- RETE ED ESISTENTE AEREA
- RETE ALTRI ESISTENTE AEREA
- RETE ESISTENTE IP INTERRATA
- RETE ESISTENTE INTERRATA
- AREA PPP
- AREA PFS
- POZZETTO 76x40
- POZZETTO 125x80
- POZZETTO 90x70
- POZZETTO 40x15
- POZZETTO 45x45
- POZZETTI TERZI ESISTENTI
- COLONNINA PFS-ARMADIO
- RFI-RETE FERROVIARIE DELLO STATO
- SS-STRADA STATALE-ANAS
- SP-STRADA PROVINCIALE

REALIZZAZIONE, POSA IN OPERA E SERVIZIO DI MANUTENZIONE
DI IMPIANTI IN FIBRA OTTICA

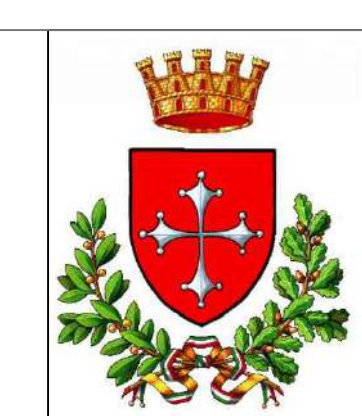

Comune di PISA
Via degli Uffizi, 1
56100 Pisa (PI)
comune.pisa@postacert.toscana.it

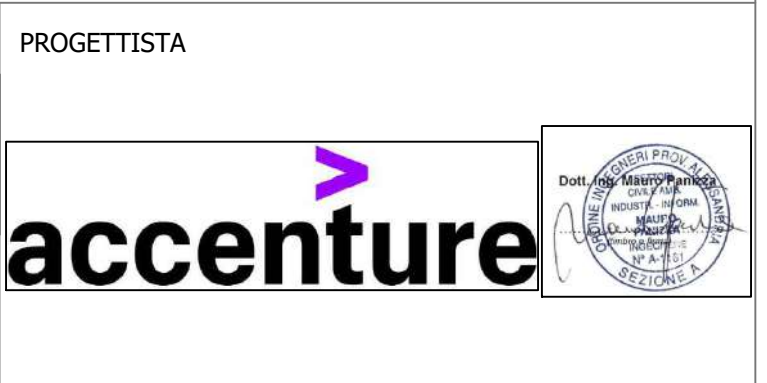

ISTANZA DI AUTORIZZAZIONE

ELABORATO PLANIMETRIA SCAVI DETTAGLIO COMUNE DI PISA AREA_EST_PISA		REDATTO VERIFICATO APPROVATO	DATA 19/06/2023	CODICE PROGETTO PISA FINANZIATO
REVISIONE	DATA	AGGIORNAMENTI	SCALA	TAVOLA
1.0	19/06/2023	-	1:2000	22
1.1	-	-	NOME FILE	
1.2	-	-	PISA-PL-S-EST-10	

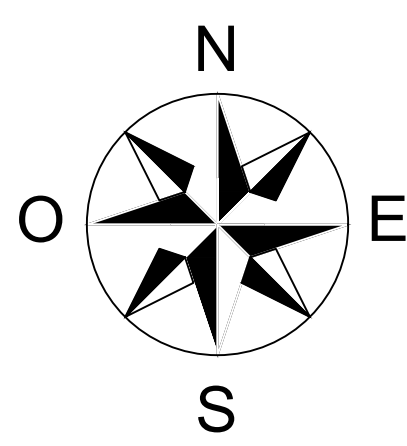

LEGENDA CIVILE

-  VINCOLO IDROGEOLOGICO REGIO DECRETO 3267/1923
-  TRINCEA TRADIZIONALE
-  MINITRINCEA
-  MICROTRINCEA
-  NO-DIG
-  CANALETTA EOF
-  RETE ED ESISTENTE AEREA
-  RETE ALTRI ESISTENTE AEREA
-  RETE ESISTENTE IP INTERRATA
-  RETE ESISTENTE INTERRATA
-  AREA PPP
-  AREA PFS
-  POZZETTO 76x40
-  POZZETTO 125x80
-  POZZETTO 90x70
-  POZZETTO 40x15
-  POZZETTO 45x45
-  POZZETTI TERZI ESISTENTI
-  COLONNINA PFS-ARMADIO
-  RFI-RETE FERROVIARIE DELLO STATO
-  SS-STRADA STATALE-ANAS
-  SP-STRADA PROVINCIALE

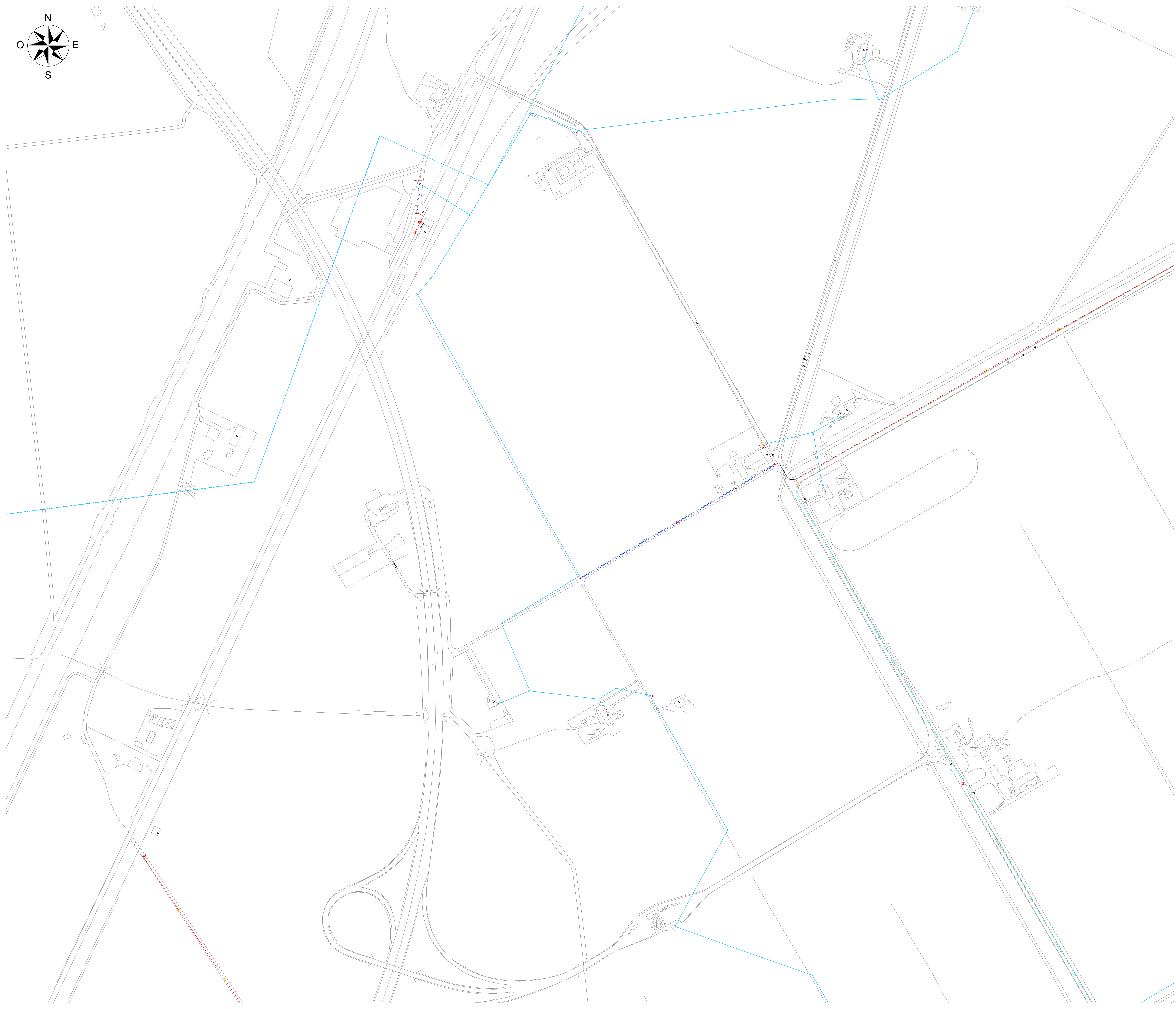

REALIZZAZIONE, POSA IN OPERA E SERVIZIO DI MANUTENZIONE
DI IMPIANTI IN FIBRA OTTICA

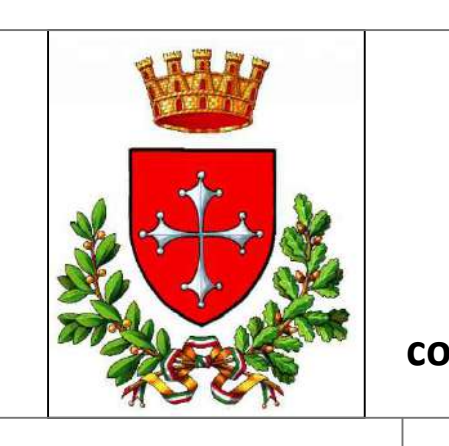



Comune di PISA
Via degli Uffizi, 1
56100 Pisa (PI)
comune.pisa@postacert.toscana.it

COMMITTENTE

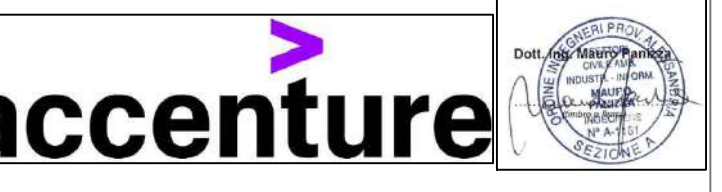

REGIONAL MANAGER
REGIONE TOSCANA
MARCO GASPARINI

PROGETTISTA







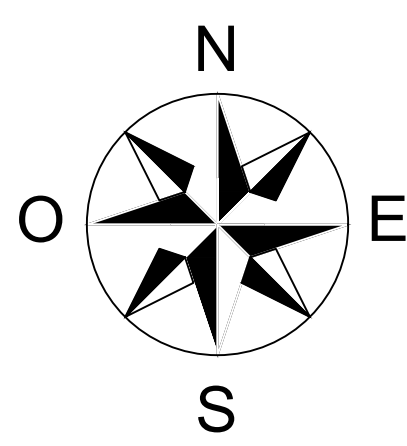





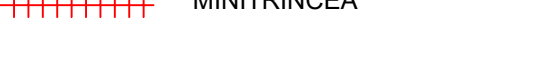









ISTANZA DI AUTORIZZAZIONE

ELABORATO		PLANIMETRIA SCAVI DETTAGLIO COMUNE DI PISA AREA_EST_PISA		DATA	
REVISIONE	DATA	AGGIORNAMENTI	SCALA	1:2000	TAVOLA
1.0	19/06/2023	-	NOME FILE	PISA-PL-S-EST-10	23
1.1	-	-	FINANZIATO		
1.2	-	-			



LEGENDA CIVILE

-  VINCOLO IDROGEOLOGICO
REGIO DECRETO 3267/1923
-  TRINCEA TRADIZIONALE
-  MINITRINCEA
-  MICROTRINCEA
-  NO-DIG
-  CANALETTA EOF
-  RETE ED ESISTENTE AEREA
-  RETE ALTRI ESISTENTE AEREA
-  RETE ESISTENTE IP INTERRATA
-  RETE ESISTENTE INTERRATA
-  AREA PPP
-  AREA PFS
-  POZZETTO 76x40
-  POZZETTO 125x80
-  POZZETTO 90x70
-  POZZETTO 48x15
-  POZZETTO 45x45
-  POZZETTI TERZI ESISTENTI
-  COLONNINA PFS-ARMADIO
-  RFI-RETE FERROVIARIE DELLO STATO
-  SS-STRADA STATALE-ANAS
-  SP-STRADA PROVINCIALE

REALIZZAZIONE, POSA IN OPERA E SERVIZIO DI MANUTENZIONE
DI IMPIANTI IN FIBRA OTTICA

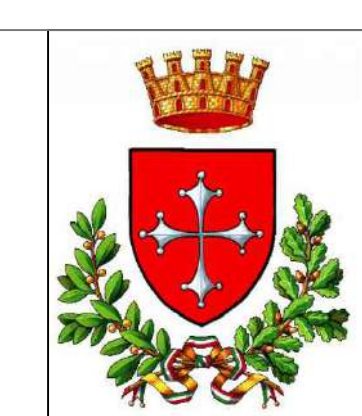

Comune di PISA
Via degli Uffizi, 1
56100 Pisa (PI)
comune.pisa@postacert.toscana.it

COMMITTENTE: **open fiber**
REGIONAL MANAGER
REGIONE TOSCANA
MARCO GASPARINI

PROGETTISTA: **accenture**

ISTANZA DI AUTORIZZAZIONE

ELABORATO			REGIONAL MANAGER REGIONE TOSCANA MARCO GASPARINI		DATA		
PLANIMETRIA SCAVI DETTAGLIO COMUNE DI PISA AREA_EST_PISA			REDAITTO				
			VERIFICATO				
			APPROVATO				
			DATA	19/06/2023	CODICE PROGETTO	PISA FINANZIATO	
REVISIONE	DATA	AGGIORNAMENTI	SCALA	1:2000	TAVOLA		
1.0	19/06/2023	-	NOME FILE				
1.1	-	-	PISA-PL-S-EST-10				
1.2	-	-					



LEGENDA CIVILE

- VINCOLO IDROGEOLOGICO
REGIO DECRETO 3267/1923
- TRINCEA TRADIZIONALE
- MINITRINCEA
- MICROTRINCEA
- NO-DIG
- CANALETTA EOF
- RETE ED ESISTENTE AEREA
- RETE ALTRI ESISTENTE AEREA
- RETE ESISTENTE IP INTERRATA
- RETE ESISTENTE INTERRATA
- AREA PPP
- AREA PFS
- POZZETTO 76x40
- POZZETTO 125x80
- POZZETTO 90x70
- POZZETTO 40x15
- POZZETTO 45x45
- POZZETTI TERZI ESISTENTI
- COLONNINA PFS-ARMADIO
- RFI-RETE FERROVIARIE DELLO STATO
- SS-STRADA STATALE-ANAS
- SP-STRADA PROVINCIALE

REALIZZAZIONE, POSA IN OPERA E SERVIZIO DI MANUTENZIONE
DI IMPIANTI IN FIBRA OTTICA



Comune di PISA
Via degli Uffizi, 1
56100 Pisa (PI)
comune.pisa@postacert.toscana.it

<p>COMMITTENTE</p> <p>REGIONAL MANAGER REGIONE TOSCANA MARCO GASPARINI</p>	<p>PROGETTISTA</p>
--	--------------------

ISTANZA DI AUTORIZZAZIONE

<p>ELABORATO</p> <p>PLANIMETRIA SCAVI DETTAGLIO COMUNE DI PISA AREA_EST_PISA</p>		<p>DATA</p> <p>19/06/2023</p>	<p>DATA</p> <p>19/06/2023</p>	<p>CODICE PROGETTO</p> <p>FISA</p>
<p>REVISIONE</p> <p>1.0</p> <p>1.1</p> <p>1.2</p>	<p>DATA</p> <p>19/06/2023</p> <p>-</p> <p>-</p>	<p>AGGIORNAMENTI</p> <p>-</p> <p>-</p> <p>-</p>	<p>SCALA</p> <p>1:2000</p>	<p>FINANZIATO</p> <p>FISA</p>
			<p>NOME FILE</p> <p>PISA-PL-S-EST-10</p>	<p>TAVOLA</p> <p>25</p>

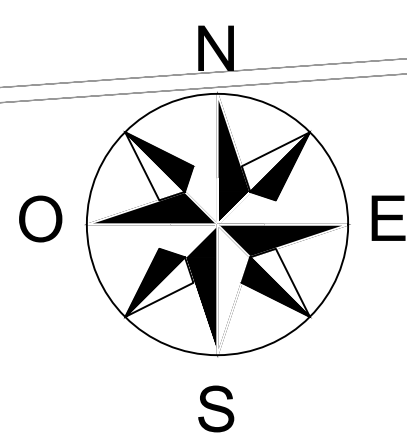

LEGENDA CIVILE

-  VINCOLO IDROGEOLOGICO
REGIO DECRETO 3267/1923
-  TRINCEA TRADIZIONALE
-  MINITRINCEA
-  MICROTRINCEA
-  NO-DIG
-  CANALETTA EOF
-  RETE ED ESISTENTE AEREA
-  RETE ALTRI ESISTENTE AEREA
-  RETE ESISTENTE IP INTERRATA
-  RETE ESISTENTE INTERRATA
-  AREA PPP
-  AREA PFS
-  POZZETTO 76x40
-  POZZETTO 125x80
-  POZZETTO 90x70
-  POZZETTO 48x15
-  POZZETTO 45x45
-  POZZETTI TERZI ESISTENTI
-  COLONNINA PFS-ARMADIO
-  RFI-RETE FERROVIARIE DELLO STATO
-  SS-STRADA STATALE-ANAS
-  SP-STRADA PROVINCIALE

COLTANO

REALIZZAZIONE, POSA IN OPERA E SERVIZIO DI MANUTENZIONE
DI IMPIANTI IN FIBRA OTTICA

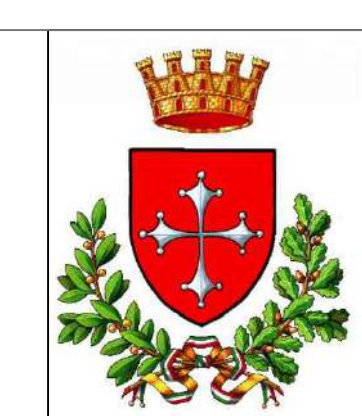



Comune di PISA
Via degli Uffizi, 1
56100 Pisa (PI)
comune.pisa@postacert.toscana.it

COMMITTENTE

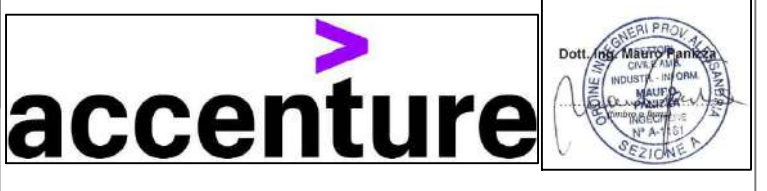

REGIONAL MANAGER
REGIONE TOSCANA
MARCO GASPARINI

PROGETTISTA

ISTANZA DI AUTORIZZAZIONE

ELABORATO PLANIMETRIA SCAVI DETTAGLIO COMUNE DI PISA AREA_EST_PISA			DATA		
			REDAITTO		
			VERIFICATO		
			APPROVATO		
REVISIONE	DATA	AGGIORNAMENTI	DATA	19/06/2023	CODICE PROGETTO FISA
1.0	19/06/2023	-	SCALA	1:2000	FINANZIATO
1.1	-	-	NOME FILE		TAVOLA
1.2	-	-	PISA-PL-S-EST-10		

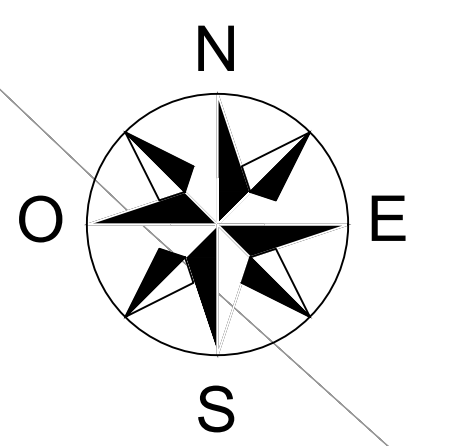

LEGENDA CIVILE

-  VINCOLO IDROGEOLOGICO
REGIO DECRETO 3267/1923
-  TRINCEA TRADIZIONALE
-  MINITRINCEA
-  MICROTRINCEA
-  NO-DIG
-  CANALETTA EOF
-  RETE ED ESISTENTE AEREA
-  RETE ALTRI ESISTENTE AEREA
-  RETE ESISTENTE IP INTERRATA
-  RETE ESISTENTE INTERRATA
-  AREA PPP
-  AREA PFS
-  POZZETTO 76x40
-  POZZETTO 125x80
-  POZZETTO 90x70
-  POZZETTO 40x15
-  POZZETTO 45x45
-  POZZETTI TERZI ESISTENTI
-  COLONNINA PFS-ARMADIO
-  RFI-RETE FERROVIARIE DELLO STATO
-  SS-STRADA STATALE-ANAS
-  SP-STRADA PROVINCIALE



REALIZZAZIONE, POSA IN OPERA E SERVIZIO DI MANUTENZIONE
DI IMPIANTI IN FIBRA OTTICA

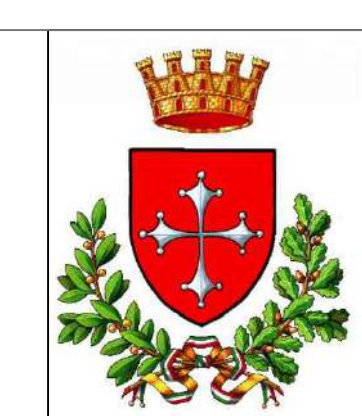

Comune di PISA
Via degli Uffizi, 1
56100 Pisa (PI)
comune.pisa@postacert.toscana.it

COMMITTENTE: **open fiber** REGIONAL MANAGER REGIONE TOSCANA MARCO GASPARINI

PROGETTISTA: **accenture**

ISTANZA DI AUTORIZZAZIONE

ELABORATO		PLANIMETRIA SCAVI DETTAGLIO COMUNE DI PISA AREA_EST_PISA		REDAITTO	DATA		
				VERIFICATO			
				APPROVATO	DATA	19/06/2023	CODICE PROGETTO PISA FINANZIATO
REVISIONE	DATA	AGGIORNAMENTI		SCALA	1:2000	TAVOLA	
1.0	19/06/2023	-		NOME FILE			
1.1	-	-		PISA-PL-S-EST-10			
1.2	-	-					

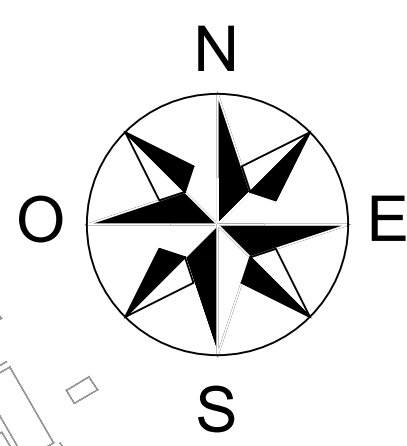

LEGENDA CIVILE

- VINCOLO IDROGEOLOGICO
REGIO DECRETO 3267/1923
- TRINCEA TRADIZIONALE
- MINITRINCEA
- MICROTRINCEA
- NO-DIG
- CANALETTA EOF
- RETE ED ESISTENTE AEREA
- RETE ALTRI ESISTENTE AEREA
- RETE ESISTENTE IP INTERRATA
- RETE ESISTENTE INTERRATA
- AREA PPP
- AREA PFS
- POZZETTO 76x40
- POZZETTO 125x80
- POZZETTO 90x70
- POZZETTO 48x15
- POZZETTO 45x45
- POZZETTI TERZI ESISTENTI
- COLONNINA PFS-ARMADIO
- RFI-RETE FERROVIARIE DELLO STATO
- SS-STRADA STATALE-ANAS
- SP-STRADA PROVINCIALE

PALAZZI

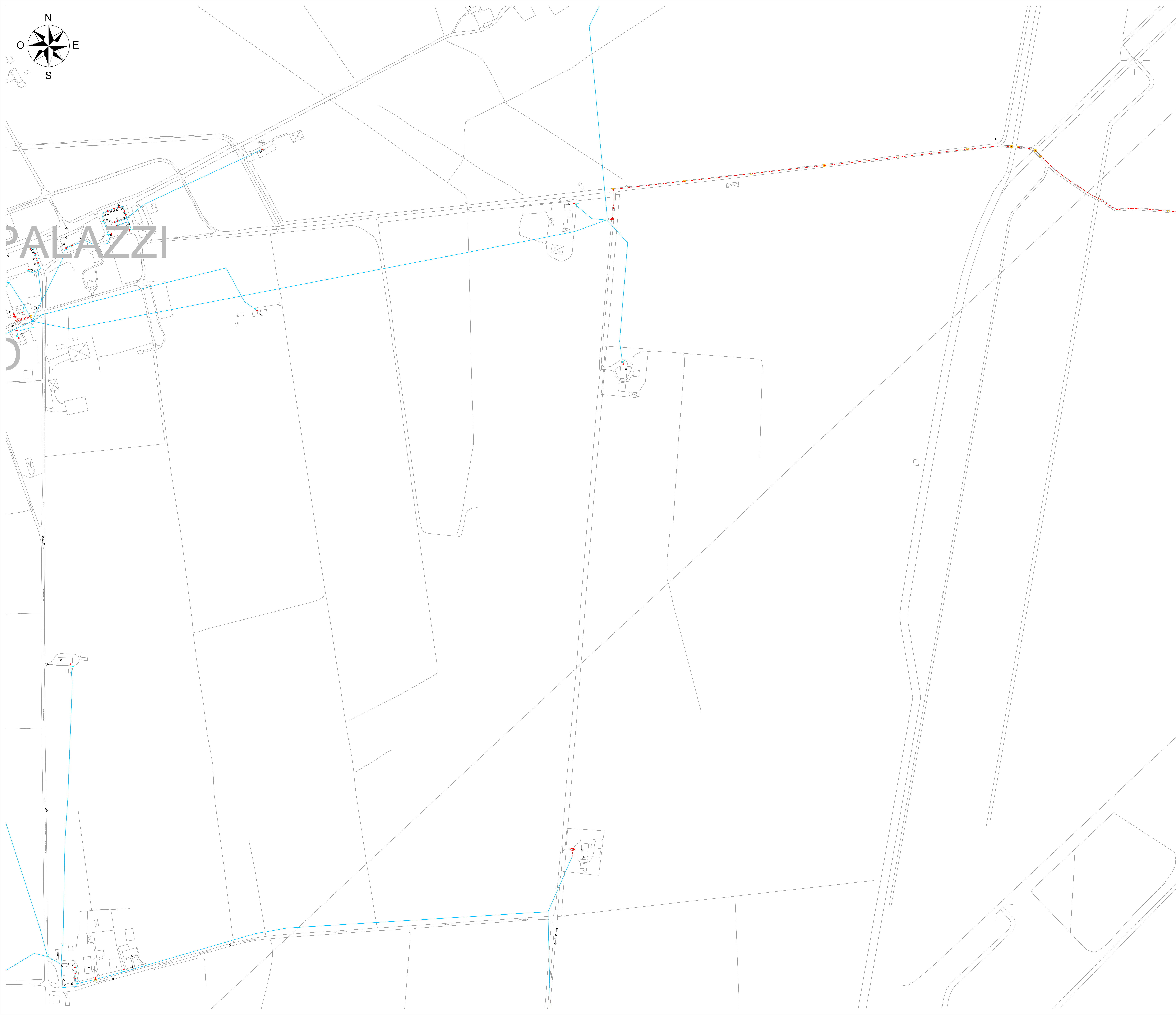

REALIZZAZIONE, POSA IN OPERA E SERVIZIO DI MANUTENZIONE
DI IMPIANTI IN FIBRA OTTICA

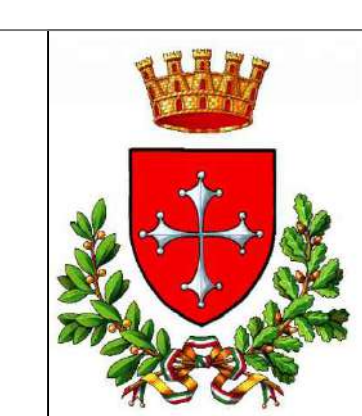

Comune di PISA
Via degli Uffizi, 1
56100 Pisa (PI)
comune.pisa@postacert.toscana.it







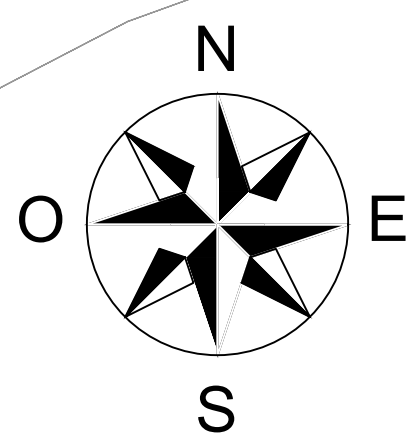





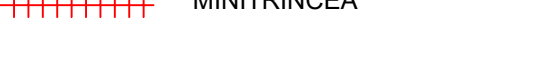





<p>COMMITTENTE</p> <p>REGIONAL MANAGER REGIONE TOSCANA MARCO GASPARINI</p>	<p>PROGETTISTA</p>
--	--------------------

ISTANZA DI AUTORIZZAZIONE

ELABORATO PLANIMETRIA SCAVI DETTAGLIO COMUNE DI PISA AREA_EST_PISA		REDATTO VERIFICATO APPROVATO	DATA 19/06/2023	CODICE PROGETTO PISA FINANZIATO
REVISIONE	DATA	AGGIORNAMENTI	SCALA	TAVOLA
1.0	19/06/2023	-	1:2000	28
1.1	-	-	NOME FILE	
1.2	-	-	PISA-PL-S-EST-10	



LEGENDA CIVILE

-  VINCOLO IDROGEOLOGICO
REGIO DECRETO 3267/1923
-  TRINCEA TRADIZIONALE
-  MINITRINCEA
-  MICROTRINCEA
-  NO-DIG
-  CANALETTA EOF
-  RETE ED ESISTENTE AEREA
-  RETE ALTRI ESISTENTE AEREA
-  RETE ESISTENTE IP INTERRATA
-  RETE ESISTENTE INTERRATA
-  AREA PPP
-  AREA PFS
-  POZZETTO 76x40
-  POZZETTO 125x80
-  POZZETTO 90x70
-  POZZETTO 48x15
-  POZZETTO 45x45
-  POZZETTI TERZI ESISTENTI
-  COLONNINA PFS-ARMADIO
-  RFI-RETE FERROVIARIE DELLO STATO
-  SS-STRADA STATALE-ANAS
-  SP-STRADA PROVINCIALE

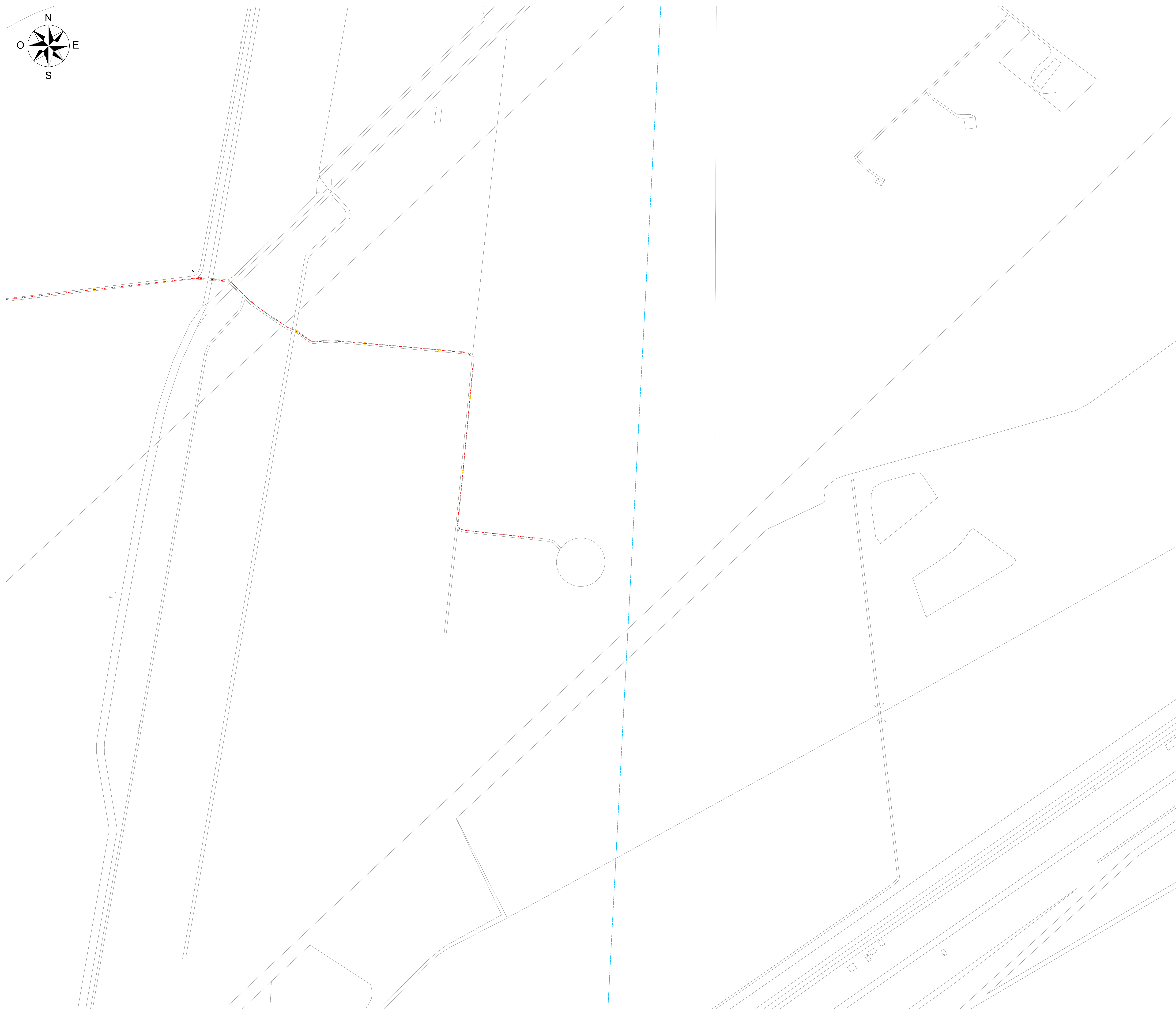

**REALIZZAZIONE, POSA IN OPERA E SERVIZIO DI MANUTENZIONE
DI IMPIANTI IN FIBRA OTTICA**



Comune di PISA
Via degli Uffizi, 1
56100 Pisa (PI)
comune.pisa@postacert.toscana.it

COMMITTENTE



REGIONAL MANAGER
REGIONE TOSCANA
MARCO GASPARIANI

PROGETTISTA



ISTANZA DI AUTORIZZAZIONE

ELABORATO		PLANIMETRIA SCAVI DETTAGLIO COMUNE DI PISA AREA_EST_PISA		DATA	
		REDAITTO		DATA	19/06/2023
		VERIFICATO		CODICE PROGETTO	PISA
		APPROVATO		FINANZIATO	
REVISIONE	DATA	AGGIORNAMENTI		SCALA	1:2000
1.0	19/06/2023	-		NOME FILE	PISA-PL-S-EST-10
1.1	-	-		TAVOLA	29
1.2	-	-			

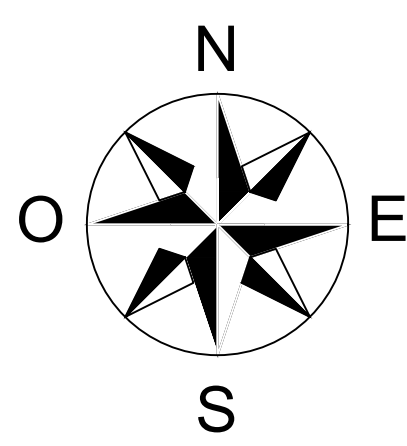

LEGENDA CIVILE

- VINCOLO IDROGEOLOGICO REGIONE TOSCANA DECRETI 3267/1923
- TRINCEA TRADIZIONALE
- MINITRINCEA
- MICROTRINCEA
- NO-DIG
- CANALETTA EOF
- RETE ED ESISTENTE AEREA
- RETE ALTRI ESISTENTE AEREA
- RETE ESISTENTE IP INTERRATA
- RETE ESISTENTE INTERRATA
- AREA PFP
- AREA PFS
- POZZETTO 76x40
- POZZETTO 125x80
- POZZETTO 90x70
- POZZETTO 48x15
- POZZETTO 45x45
- POZZETTI TERZI ESISTENTI
- COLONNINA PFS-ARMADIO
- RFI-RETE FERROVIARIE DELLO STATO
- SS-STRADA STATALE-ANAS
- SP-STRADA PROVINCIALE

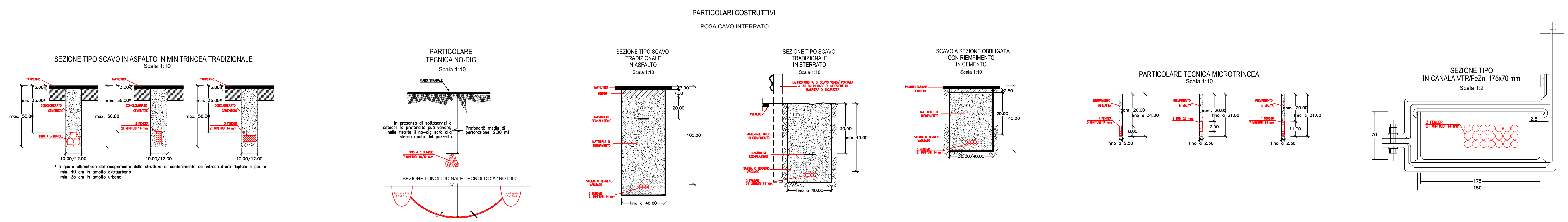

ESPLOSI ASSONOMETRICI DI POZZETTI MODULARI

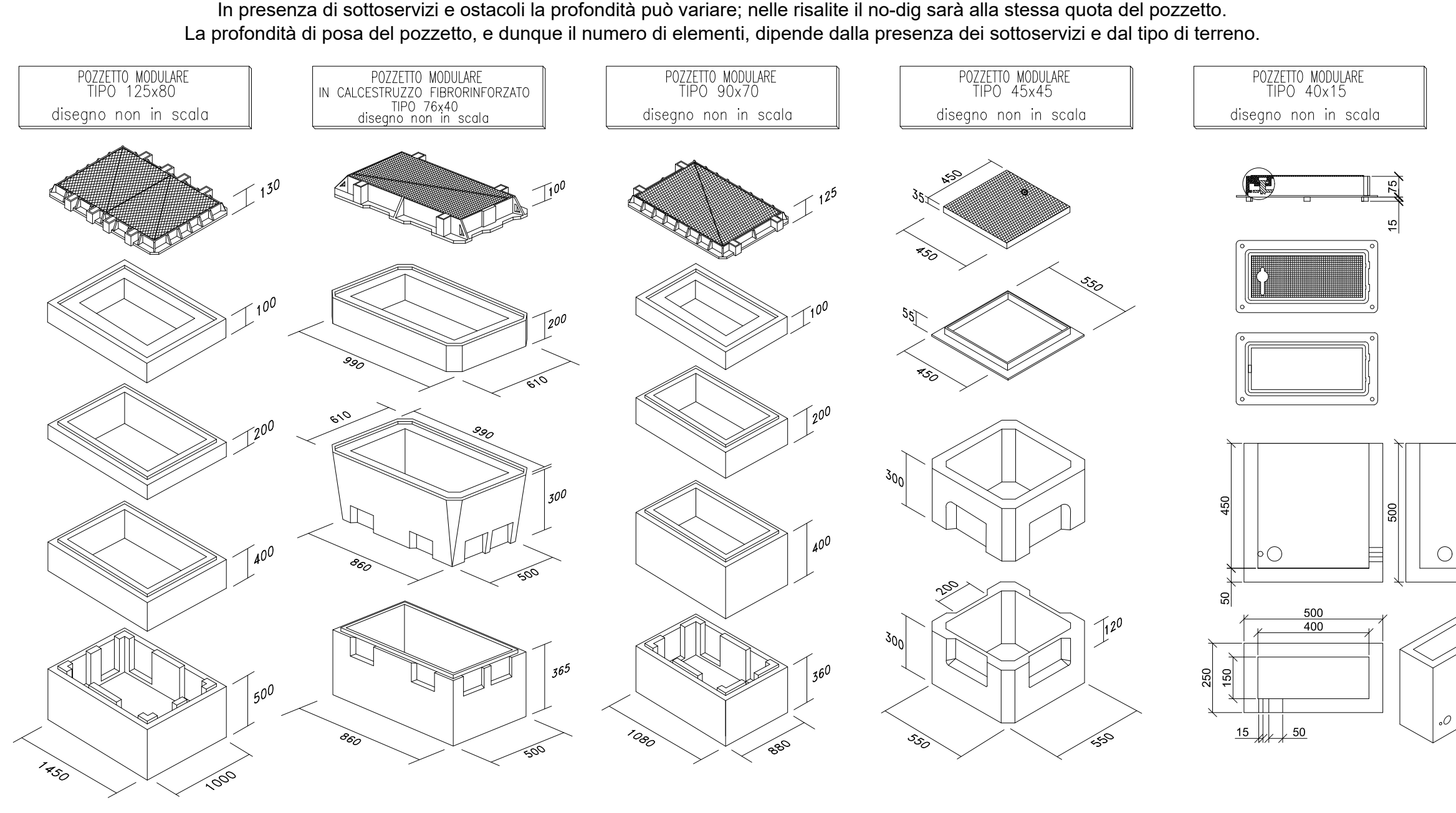

PARTICOLARE ARMADIO CAB8 MASTER - VISTE FRONTALI E LATERALI

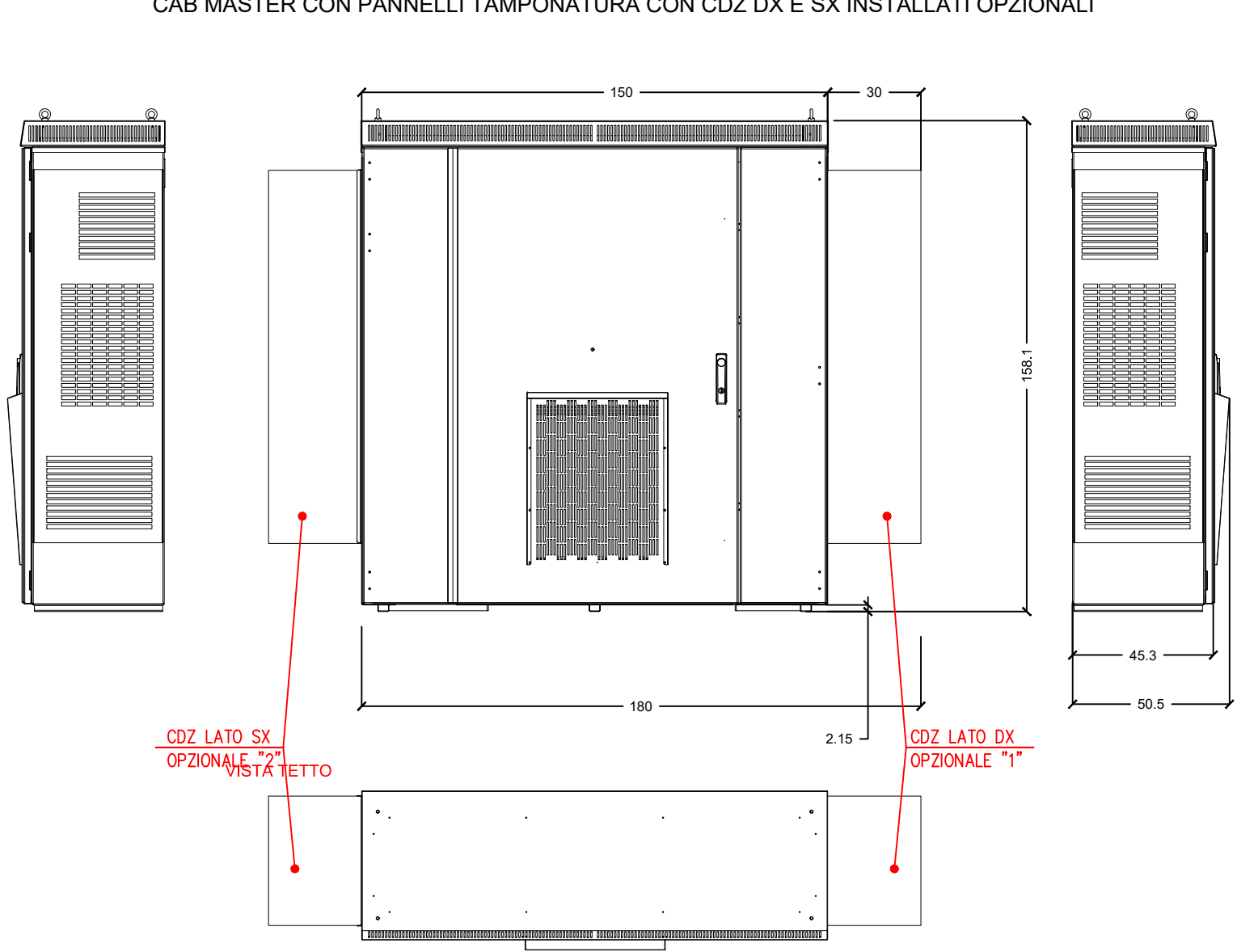

PARTICOLARE ARMADIO CABS4M

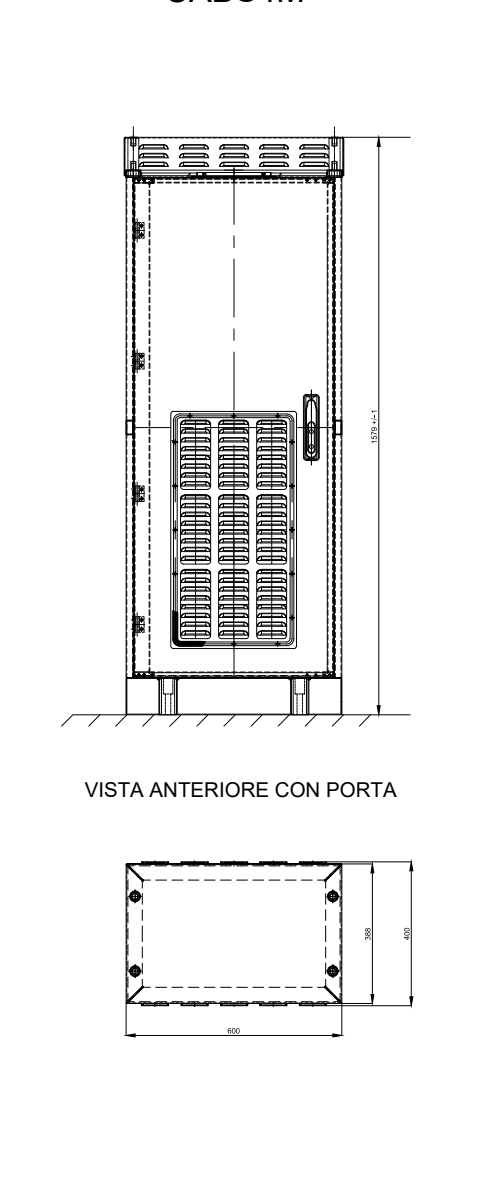

PARTICOLARE ARMADIO CAB SF

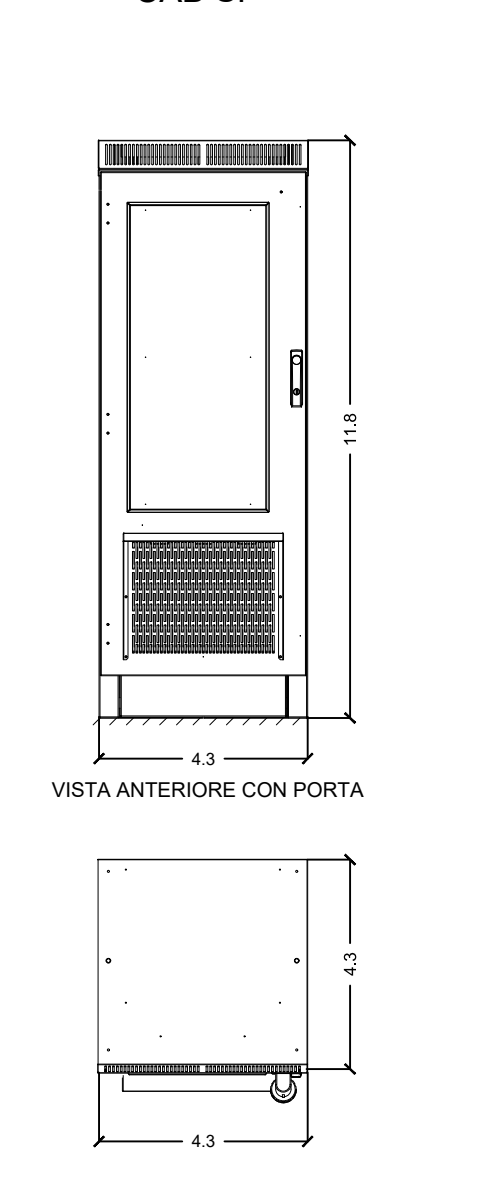

ROE A COLONNINA

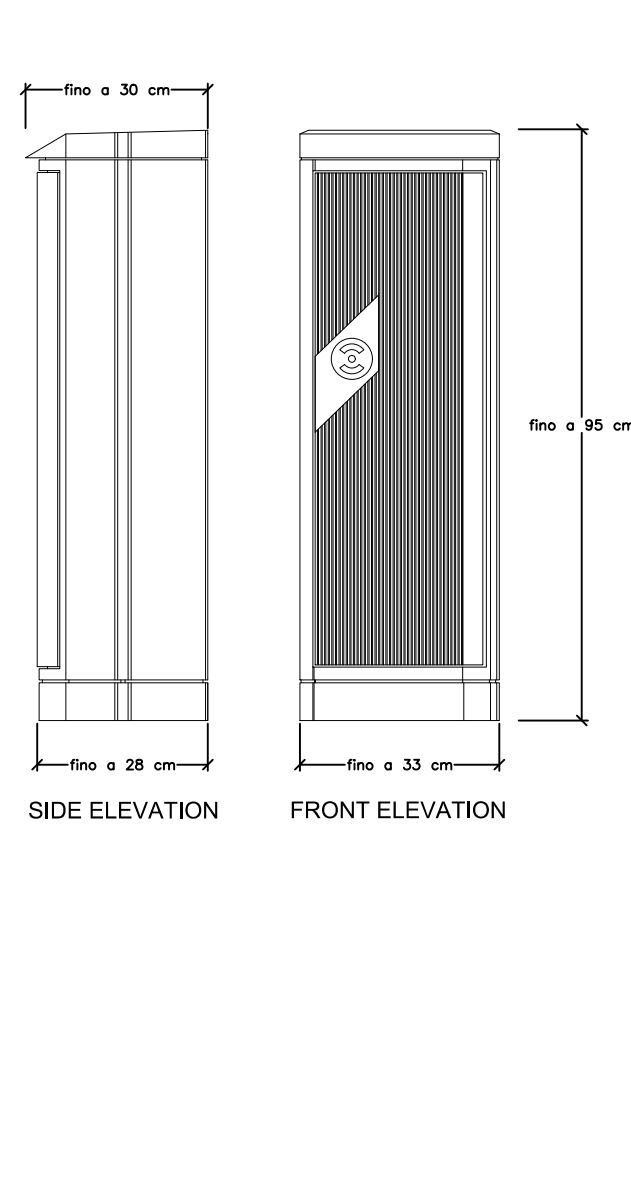

POSA CAVO IN PALIFICATA ESISTENTE

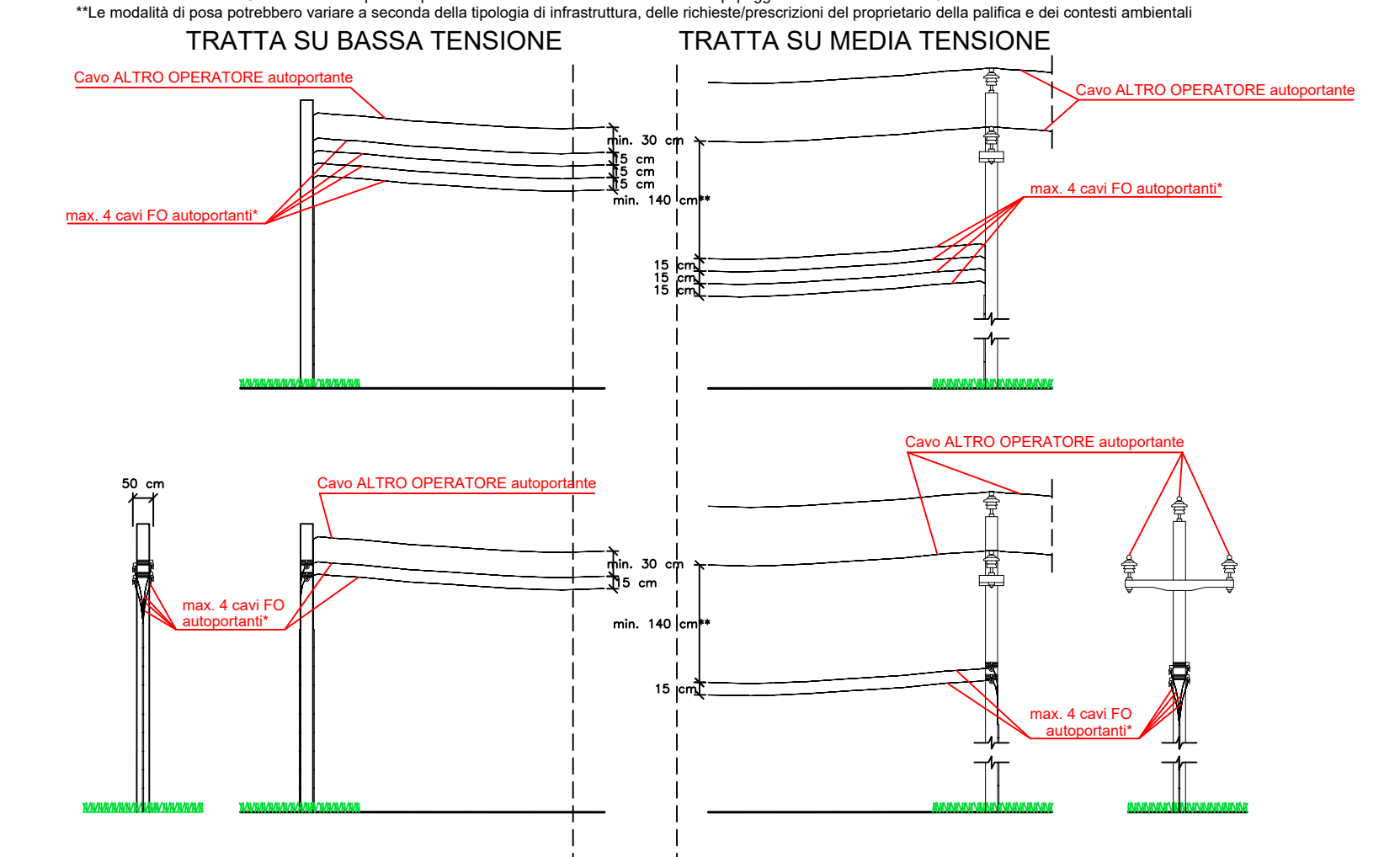

POSA CAVO IN FACCIATA

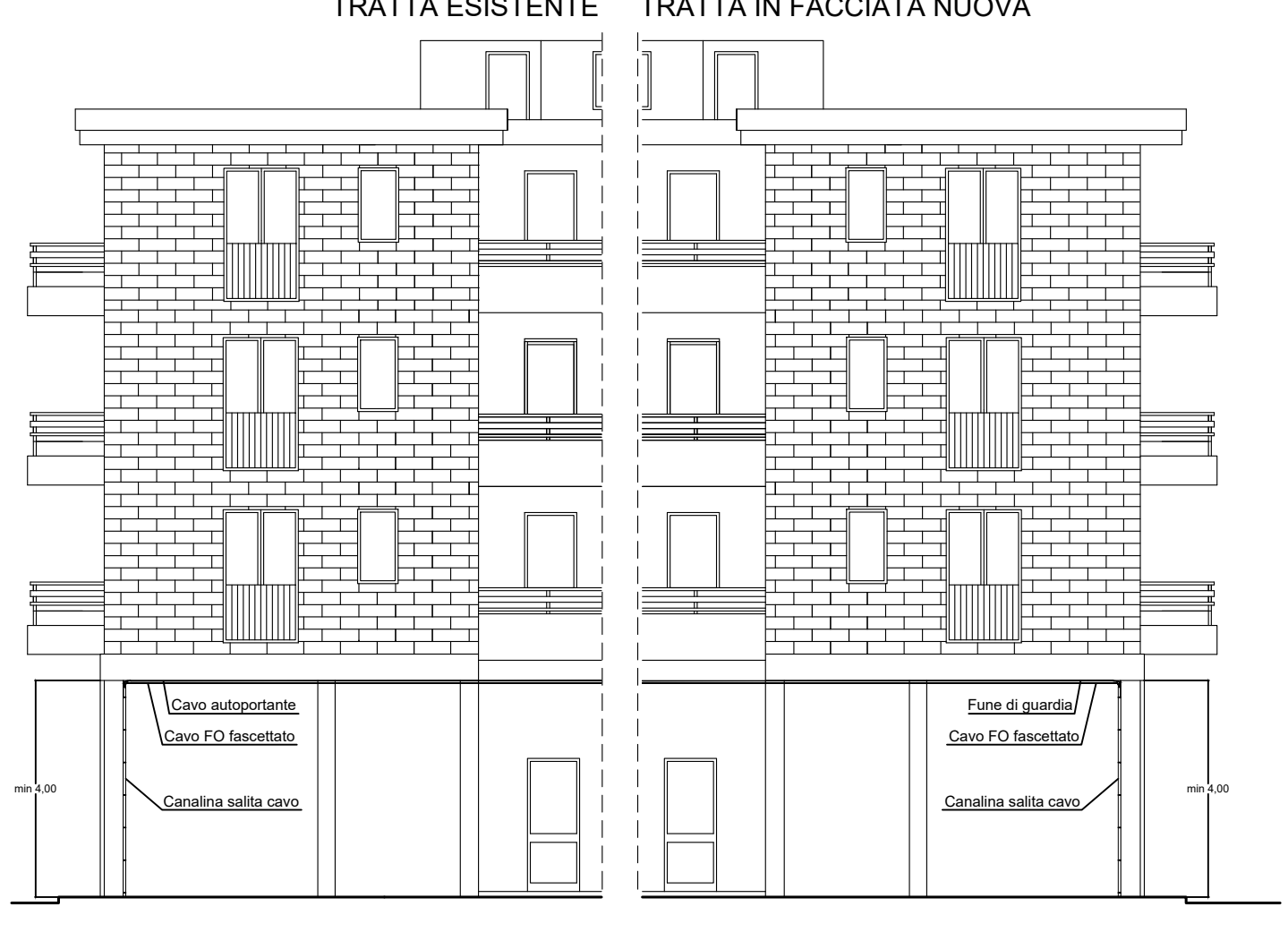

ARMADIO OF

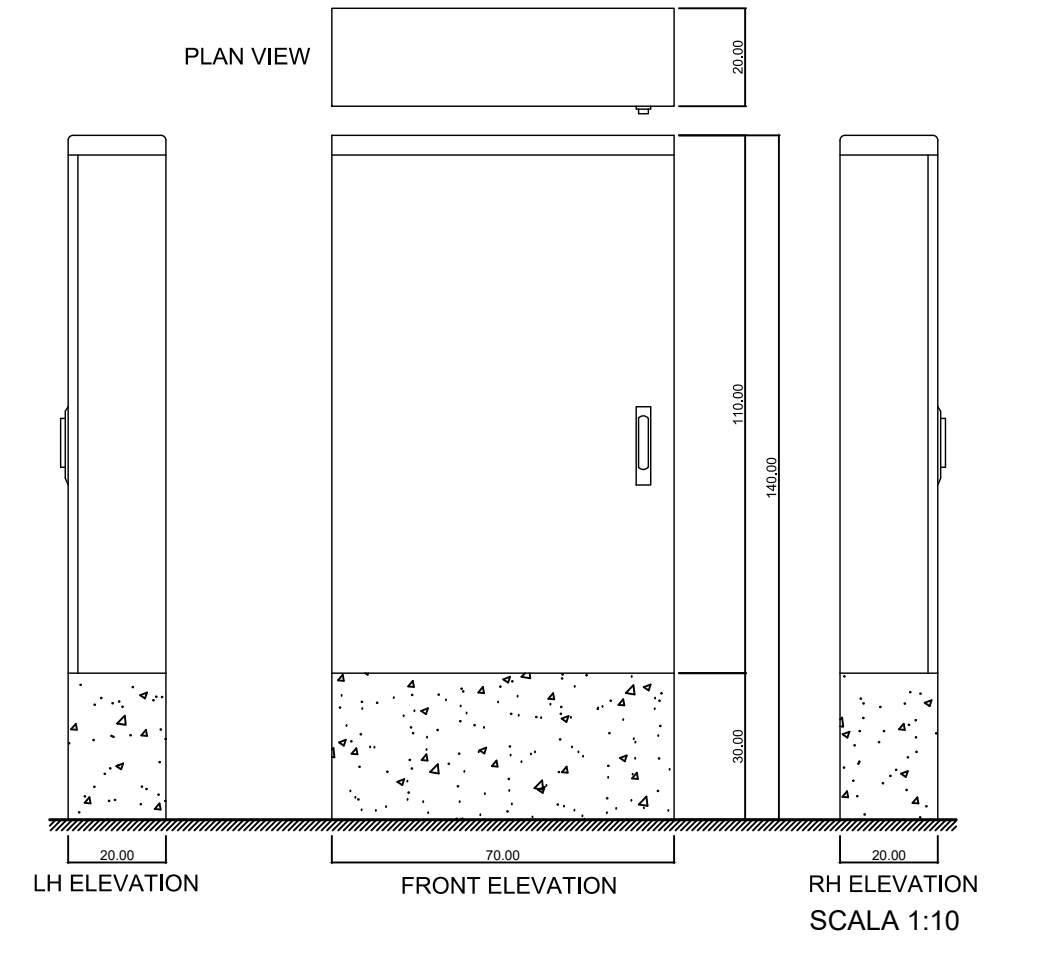

POSA CAVO IN PALIFICATA NUOVA

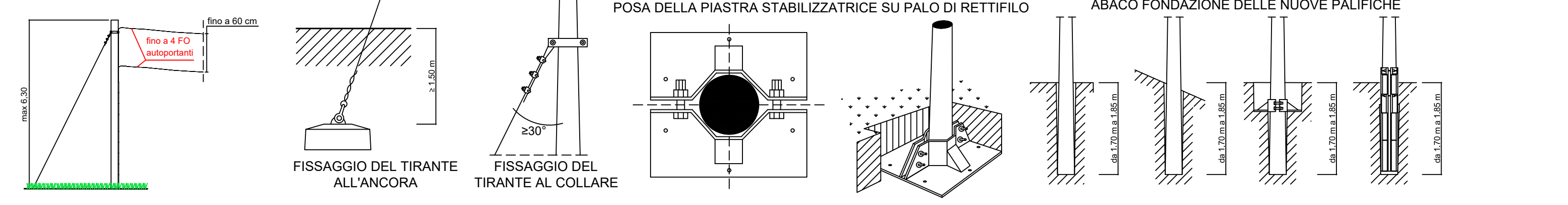

REALIZZAZIONE, POSA IN OPERA E SERVIZIO DI MANUTENZIONE
DI IMPIANTI IN FIBRA OTTICA

Comune di PISA
Via degli Uffici, 1
56100 Pisa (PI)
comune.pisa@postacert.toscana.it

COMMITTENTE

REGIONAL MANAGER
REGIONE TOSCANA
MARCO GASPARINI

PROGETTISTA

ISTANZA DI AUTORIZZAZIONE

ELABORATO		PLANIMETRIA SCAVI FOTOINSERIMENTI - PARTICOLARI COSTRUTTIVI COMUNE DI PISA AREA_EST_PISA		DATA	
REVISIONE	DATA	AGGIORNAMENTI	SCALA	DATA	CODICE PROGETTO
1.0	19/06/2023	-	VARIE	19/06/2023	FISA FINANZIATO
1.1	-	-	NOME FILE		TAVOLA
1.2	-	-	PISA-PL-S-AREA_EST-10		FOTOINSERIMENTI PART. COSTR.

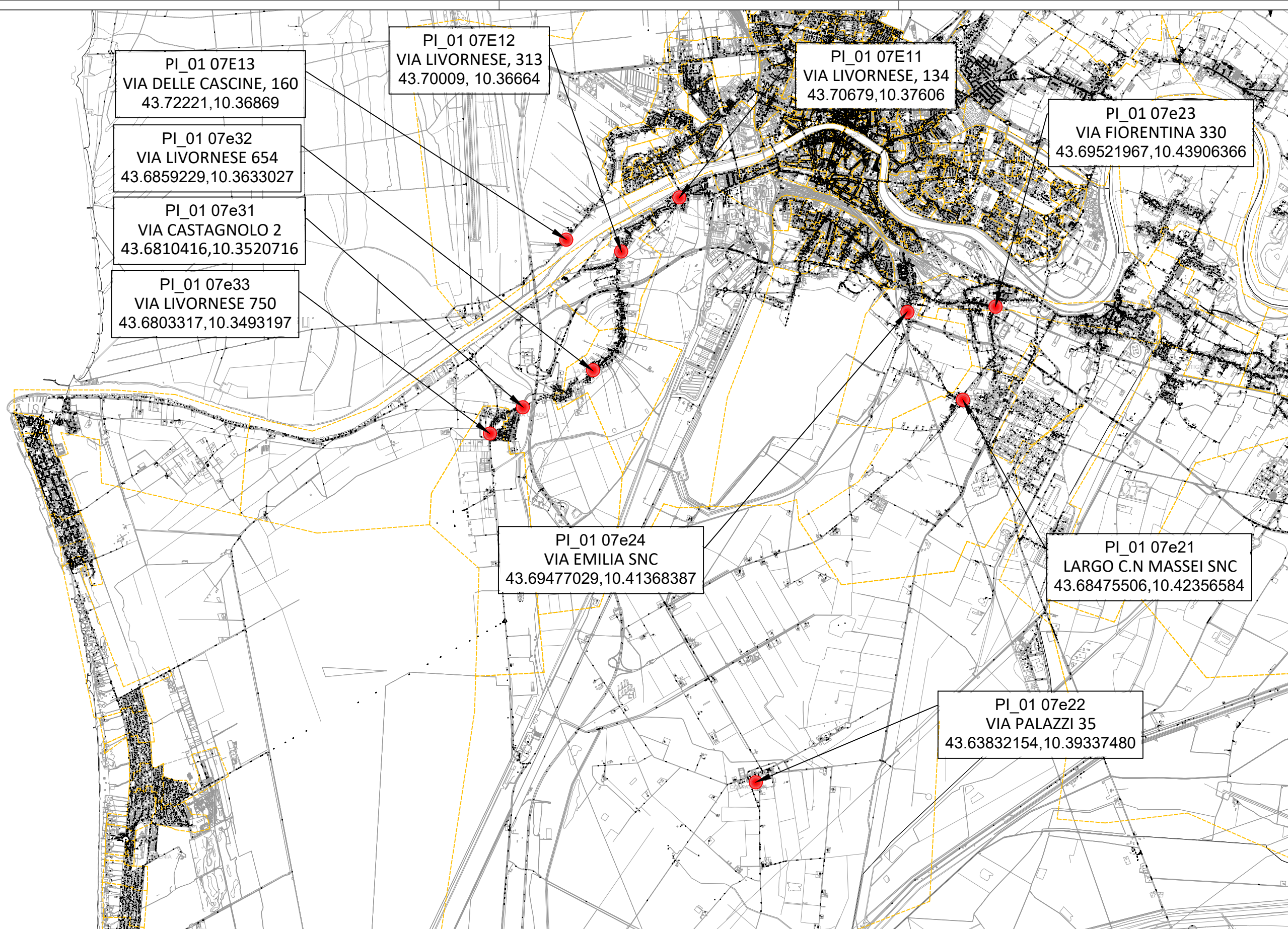

PI_01 07E13
VIA DELLE CASCINE, 160
43.72221,10.36869

PI_01 07E12
VIA LIVORNESE, 313
43.70009, 10.36664

PI_01 07E11
VIA LIVORNESE, 134
43.70679,10.37606

PI_01 07E23
VIA FIORENTINA 330
43.69521967,10.43906366

PI_01 07E32
VIA LIVORNESE 654
43.6859229,10.3633027

PI_01 07E31
VIA CASTAGNOLO 2
43.6810416,10.3520716

PI_01 07E33
VIA LIVORNESE 750
43.6803317,10.3493197

PI_01 07E24
VIA EMILIA SNC
43.69477029,10.41368387

PI_01 07E21
LARGO C.N MASSEI SNC
43.68475506,10.42356584

PI_01 07E22
VIA PALAZZI 35
43.63832154,10.39337480



Comune di PISA
Via degli Uffizi, 1 56100 Pisa (PI)
comune.pisa@postacert.toscana.it

COMMITTENTE



REGIONAL MANAGER
REGIONE TOSCANA
MARCO GASPARINI

PROGETTISTA



REALIZZAZIONE, POSA IN OPERA E
SERVIZIO DI MANUTENZIONE DI
IMPIANTI IN FIBRA OTTICA

ISTANZA DI
AUTORIZZAZIONE

ELABORATO

COROGRAFIA
COMUNE DI
PISA
PISA_EST

SCALA

1: 50000

NOME FILE

PISA-PL-A-EST

DATA 19/06/2023

CODICE PROGETTO

PISA FINANZIATO

TAVOLA

QU

Formato stampa A3

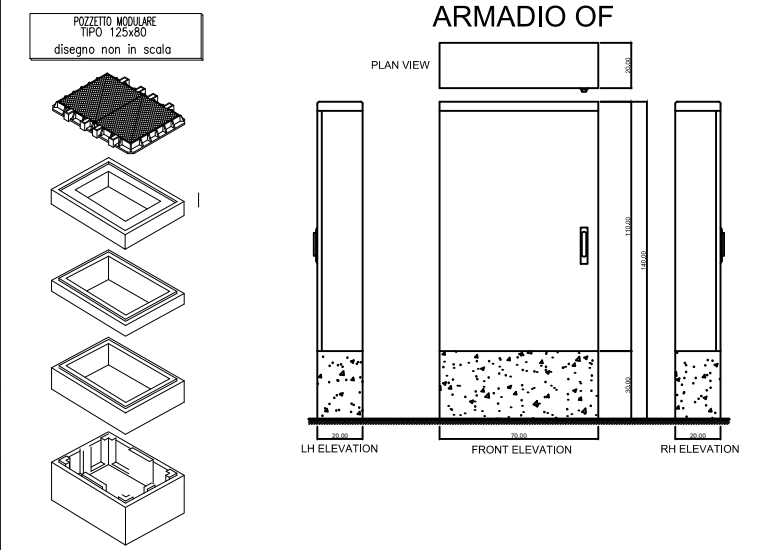
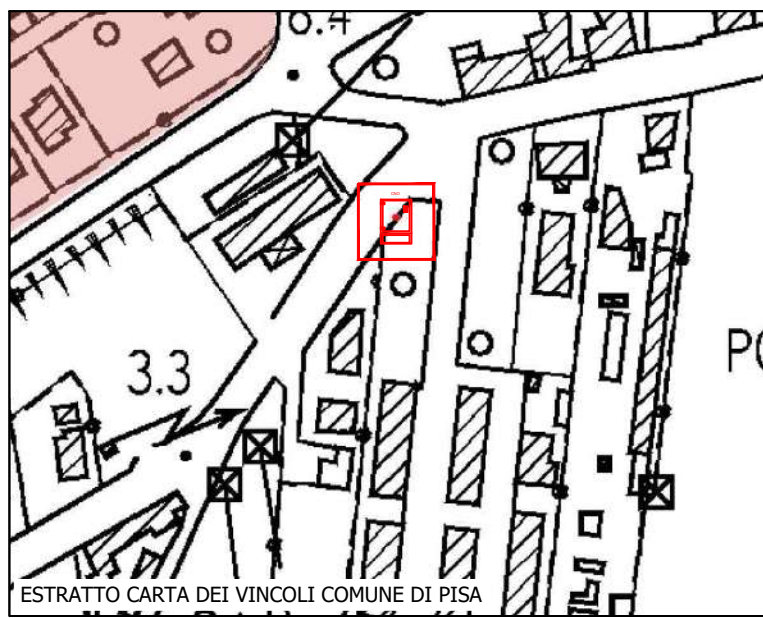
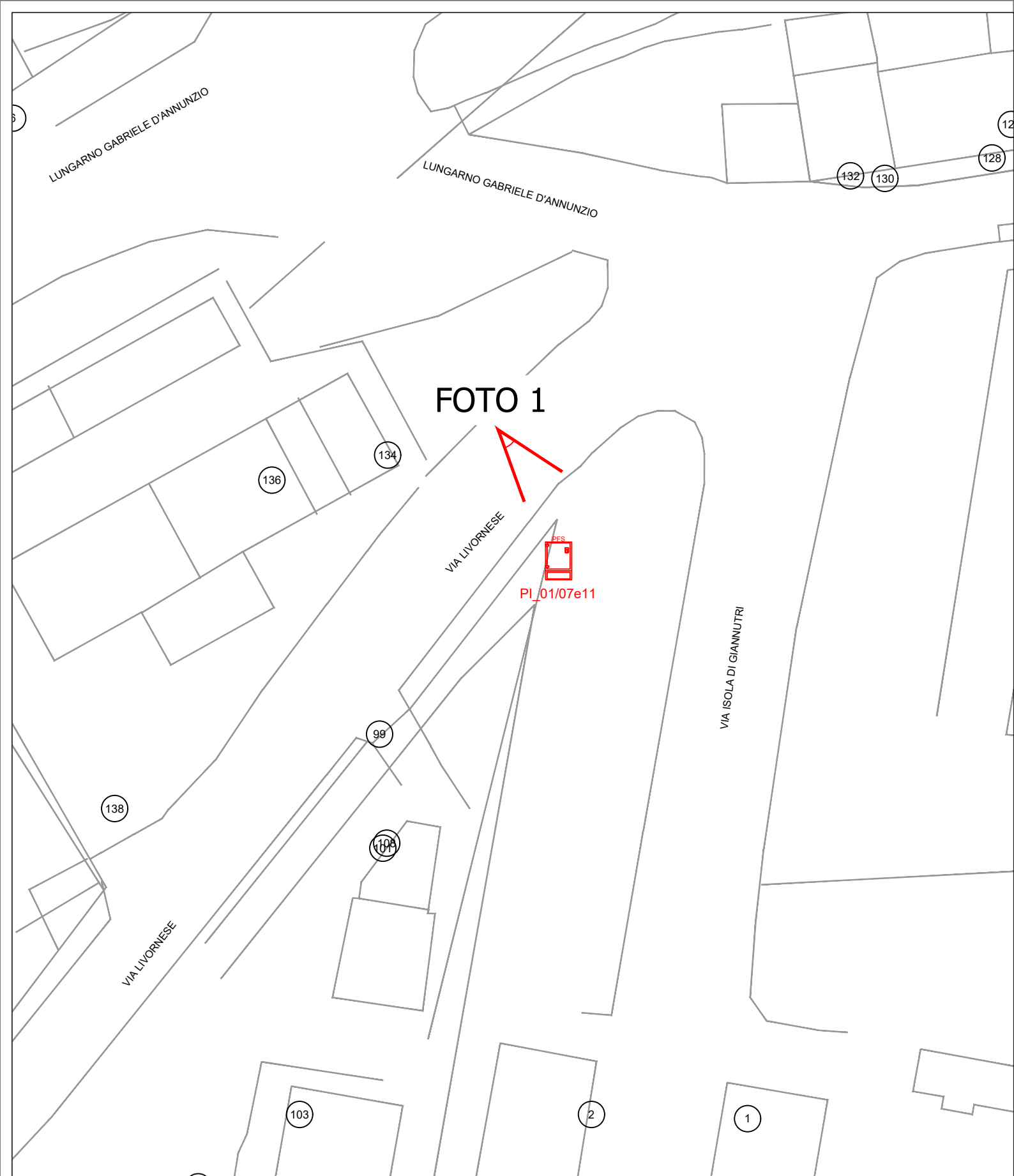

UBICAZIONE ARMADIO
 PI_01 07E11
 VIA LIVORNESE, 134
 43.70679,10.37606

LEGENDA

- ARMADIO TECNICO IN VINCOLO PAESAGGISTICO
- ARMADIO TECNICO NON IN VINCOLO PAESAGGISTICO

Comune di Pisa
 Via degli Uffici, 1 56100 Pisa (PI)
 comune.pisa@postacert.toscana.it

COMMITTENTE

open fiber

REGIONAL MANAGER
 REGIONE TOSCANA
 MARCO GASPARINI

PROGETTISTA

accenture

REALIZZAZIONE, POSA IN OPERA E SERVIZIO DI MANUTENZIONE DI IMPIANTI IN FIBRA OTTICA

ISTANZA DI AUTORIZZAZIONE

ELABORATO

COROGRAFIA
 COMUNE DI PISA
 AREA_EST

SCALA	CODICE PROGETTO
1: 500	PISA FINANZIATO
NOME FILE	TAVOLA
PISA-PL-A-AREA_EST	01
DATA 19/06/2023	Formato stampa A3

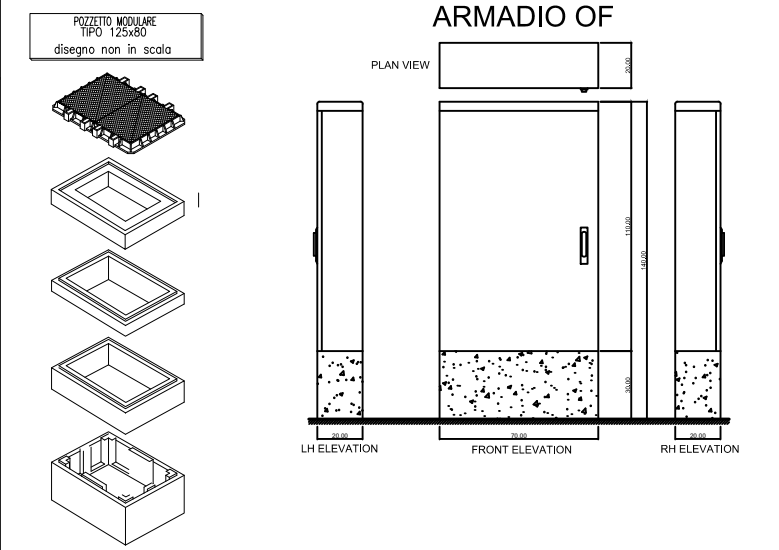
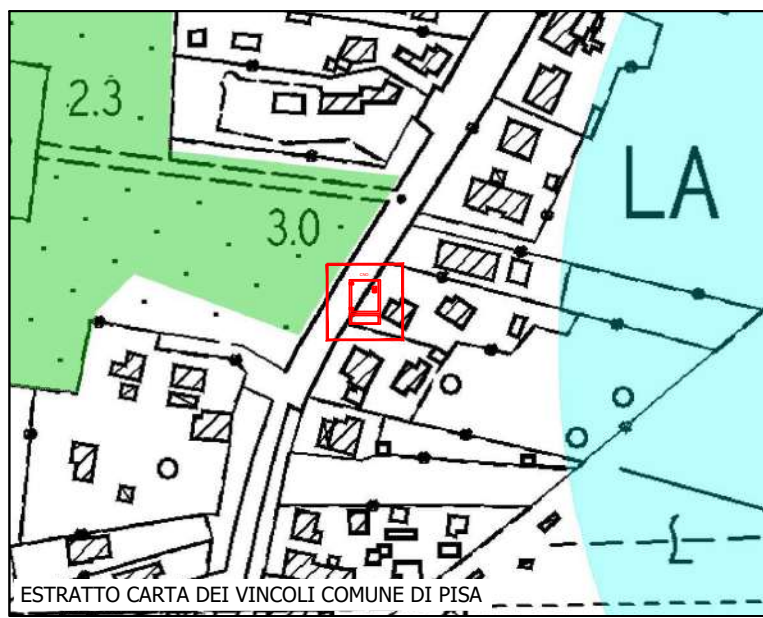
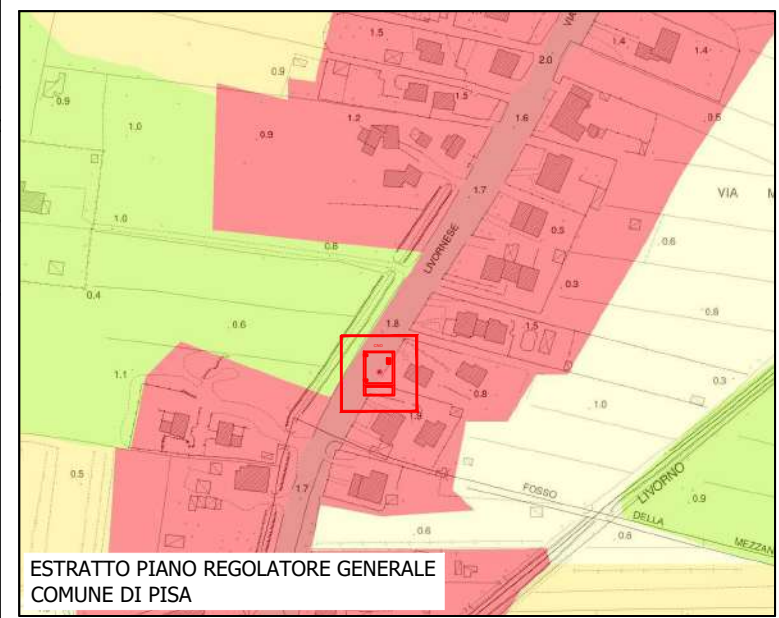
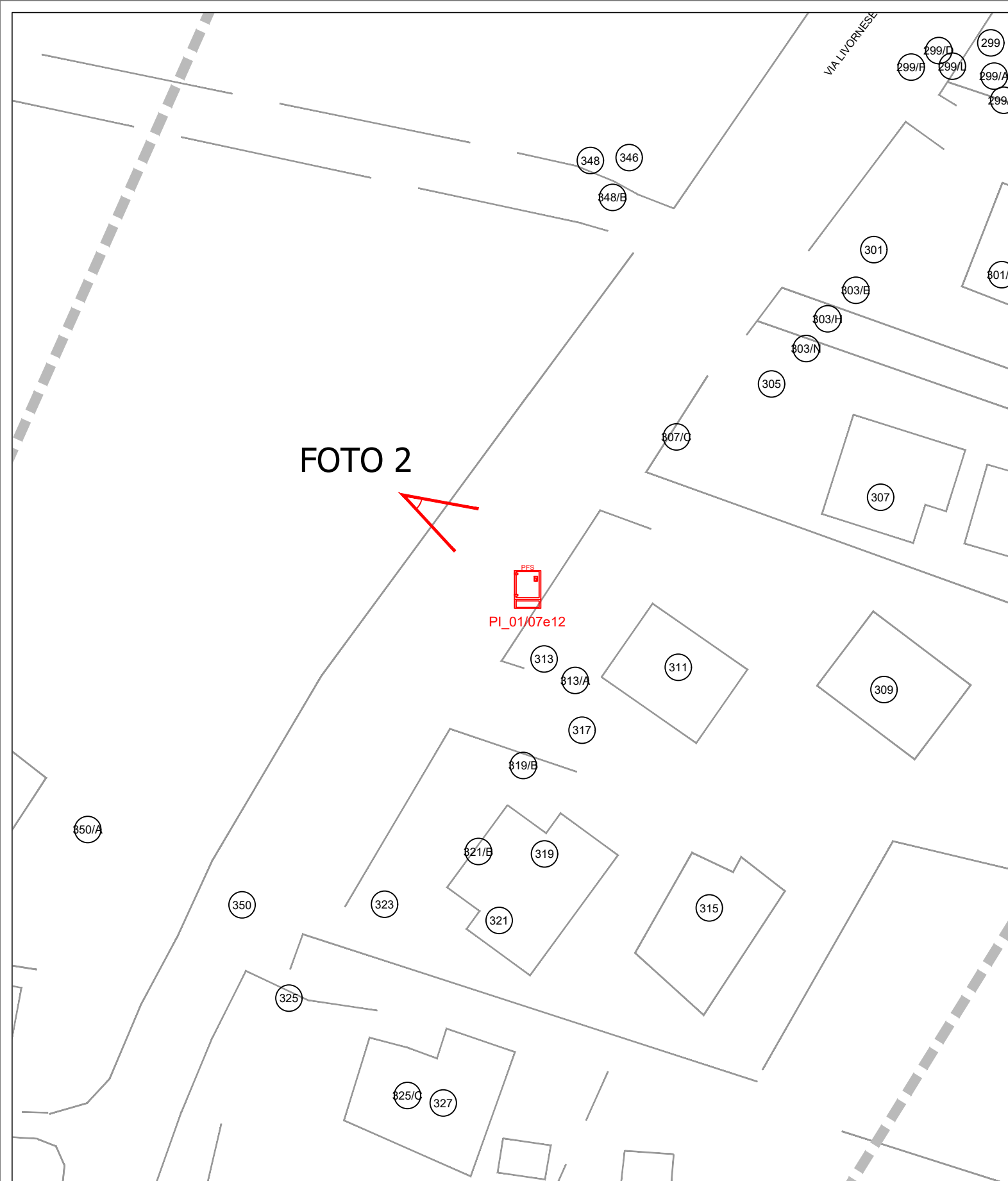

UBICAZIONE ARMADIO
 PI_01 07E12
 VIA LIVORNESE, 313
 43.70009, 10.36664

LEGENDA

ARMADIO TECNICO IN VINCOLO PAESAGGISTICO

ARMADIO TECNICO NON IN VINCOLO PAESAGGISTICO

Comune di Pisa
 Via degli Uffizi, 1 56100 Pisa (PI)
 comune.pisa@postacert.toscana.it

COMMITTENTE

open fiber

REGIONAL MANAGER
 REGIONE TOSCANA
 MARCO GASPARINI

PROGETTISTA

accenture

REALIZZAZIONE, POSA IN OPERA E SERVIZIO DI MANUTENZIONE DI IMPIANTI IN FIBRA OTTICA

ISTANZA DI AUTORIZZAZIONE



ELABORATO

COROGRAFIA
 COMUNE DI PISA
 AREA_EST

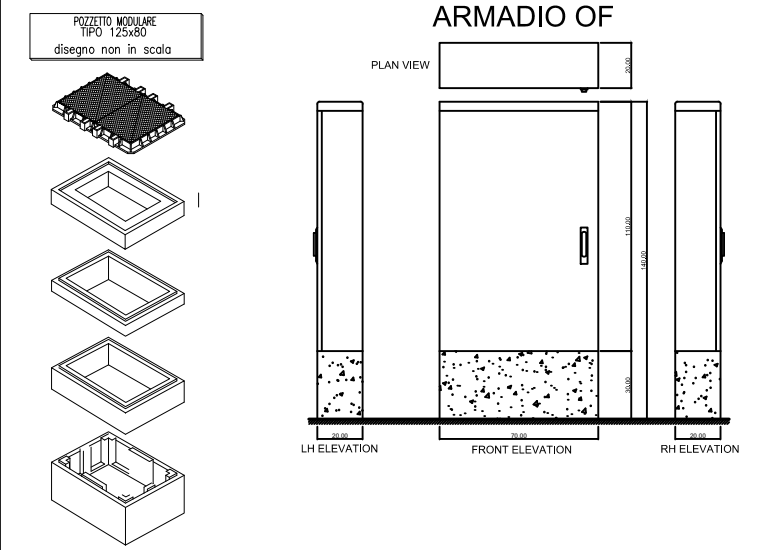
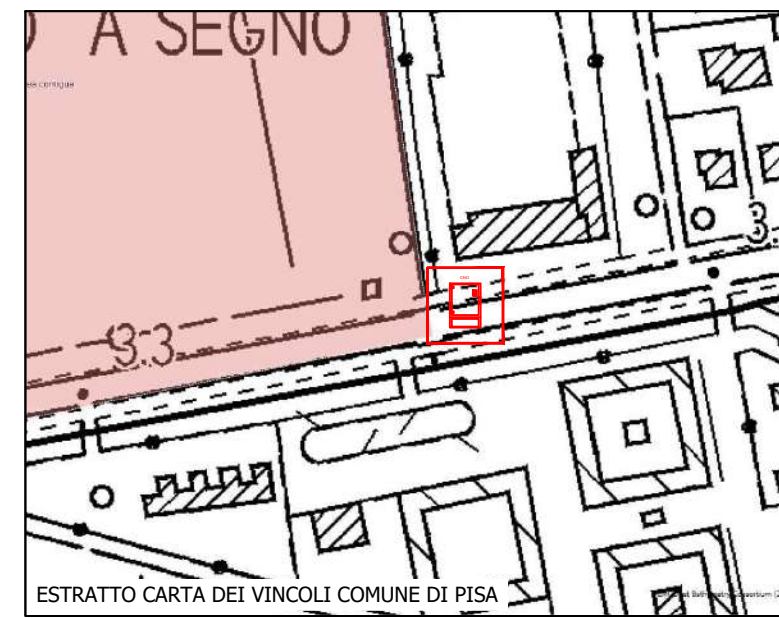
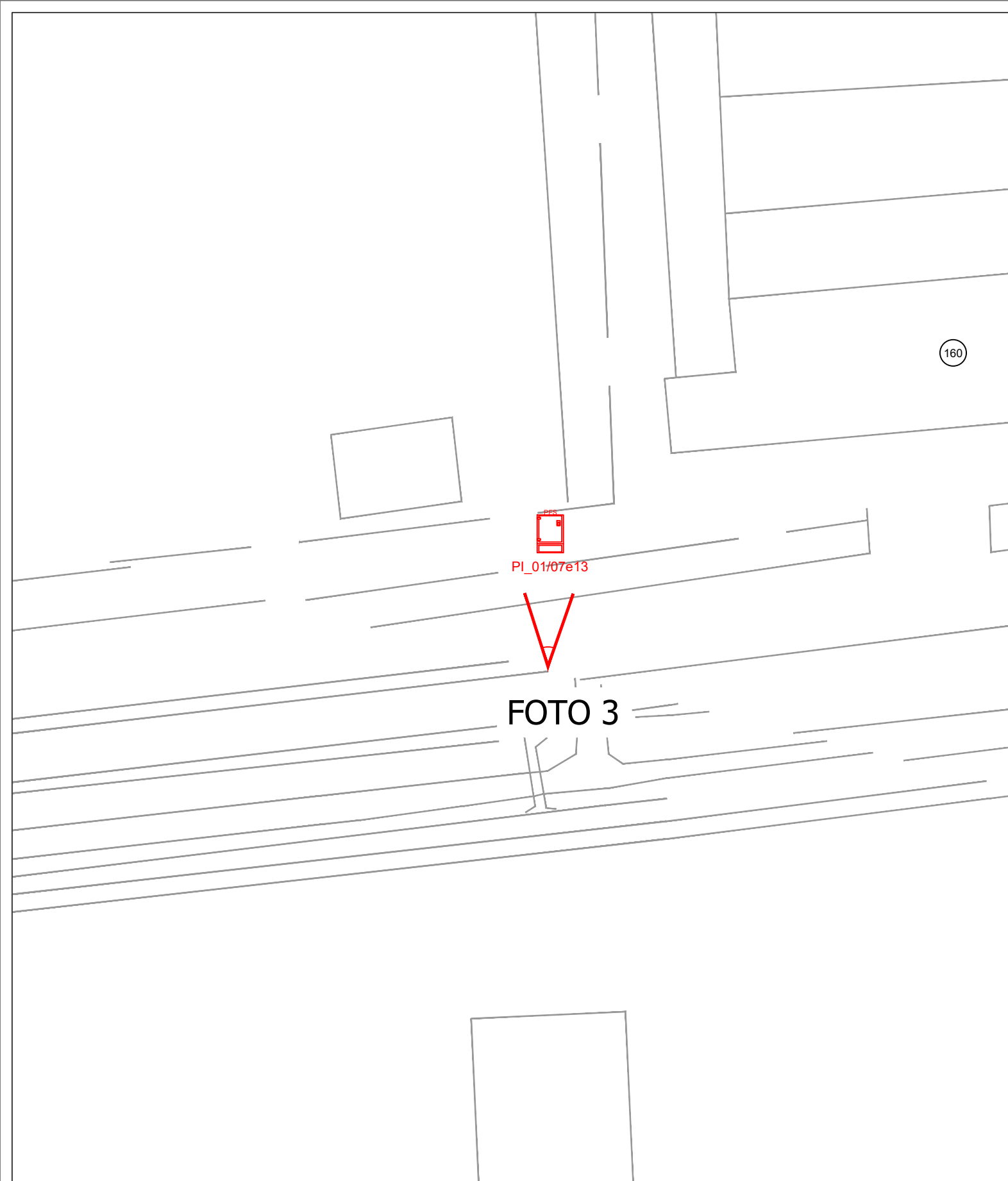
SCALA	CODICE PROGETTO
1: 500	PISA FINANZIATO
NOME FILE	TAVOLA
PISA-PL-A-AREA_EST	02
DATA 19/06/2023	Formato stampa A3



UBICAZIONE ARMADIO
 PI_01 07E13
 VIA DELLE CASCINE, 160
 43.72221,10.36869

LEGENDA
 ARMADIO TECNICO IN VINCOLO PAESAGGISTICO
 ARMADIO TECNICO NON IN VINCOLO PAESAGGISTICO



Comune di PISA
 Via degli Uffizi, 1 56100 Pisa (PI)
 comune.pisa@postacert.toscana.it

COMMITTENTE



REGIONAL MANAGER
 REGIONE TOSCANA
 MARCO GASPARINI

PROGETTISTA



REALIZZAZIONE, POSA IN OPERA E SERVIZIO DI MANUTENZIONE DI IMPIANTI IN FIBRA OTTICA

ISTANZA DI AUTORIZZAZIONE

ELABORATO
 COROGRAFIA
 COMUNE DI PISA
 AREA_EST

SCALA
1: 500
 NOME FILE
 PISA-PL-A-AREA_EST
 DATA 19/06/2023

CODICE PROGETTO
 PISA FINANZIATO
 TAVOLA
03
 Formato stampa A3

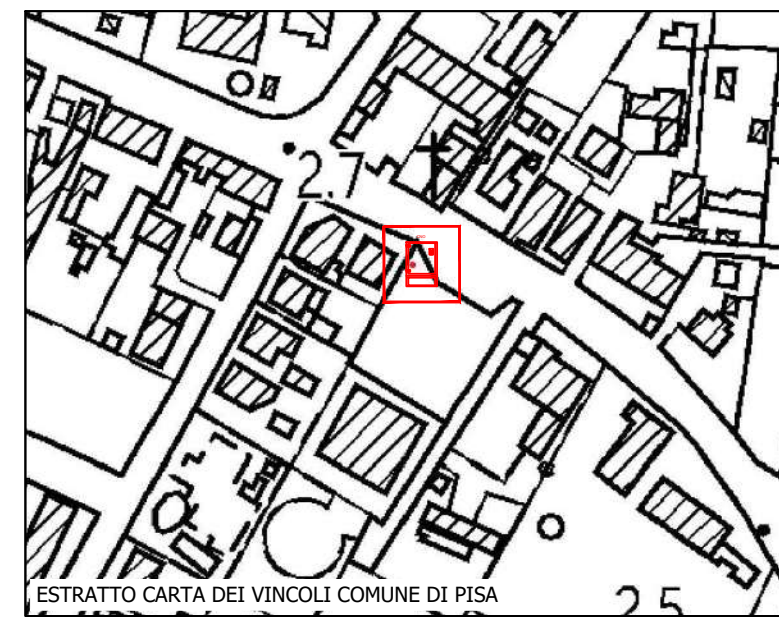
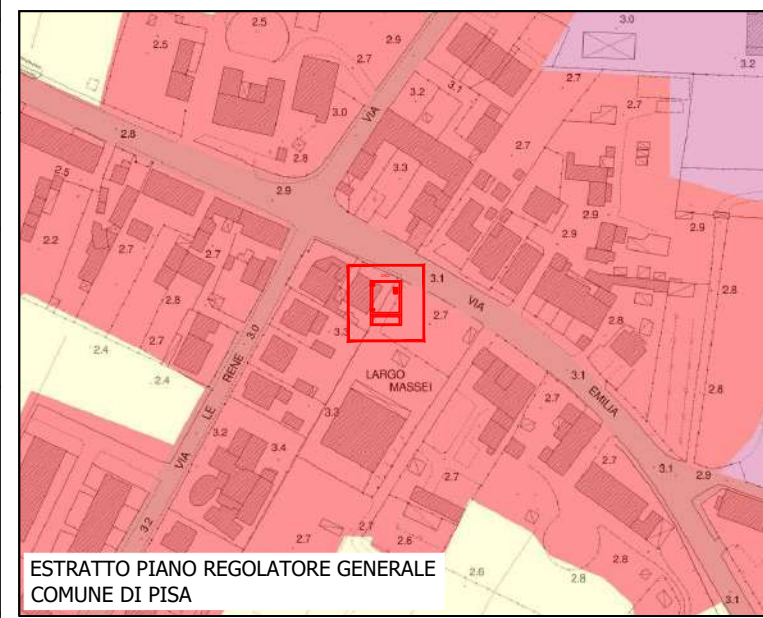
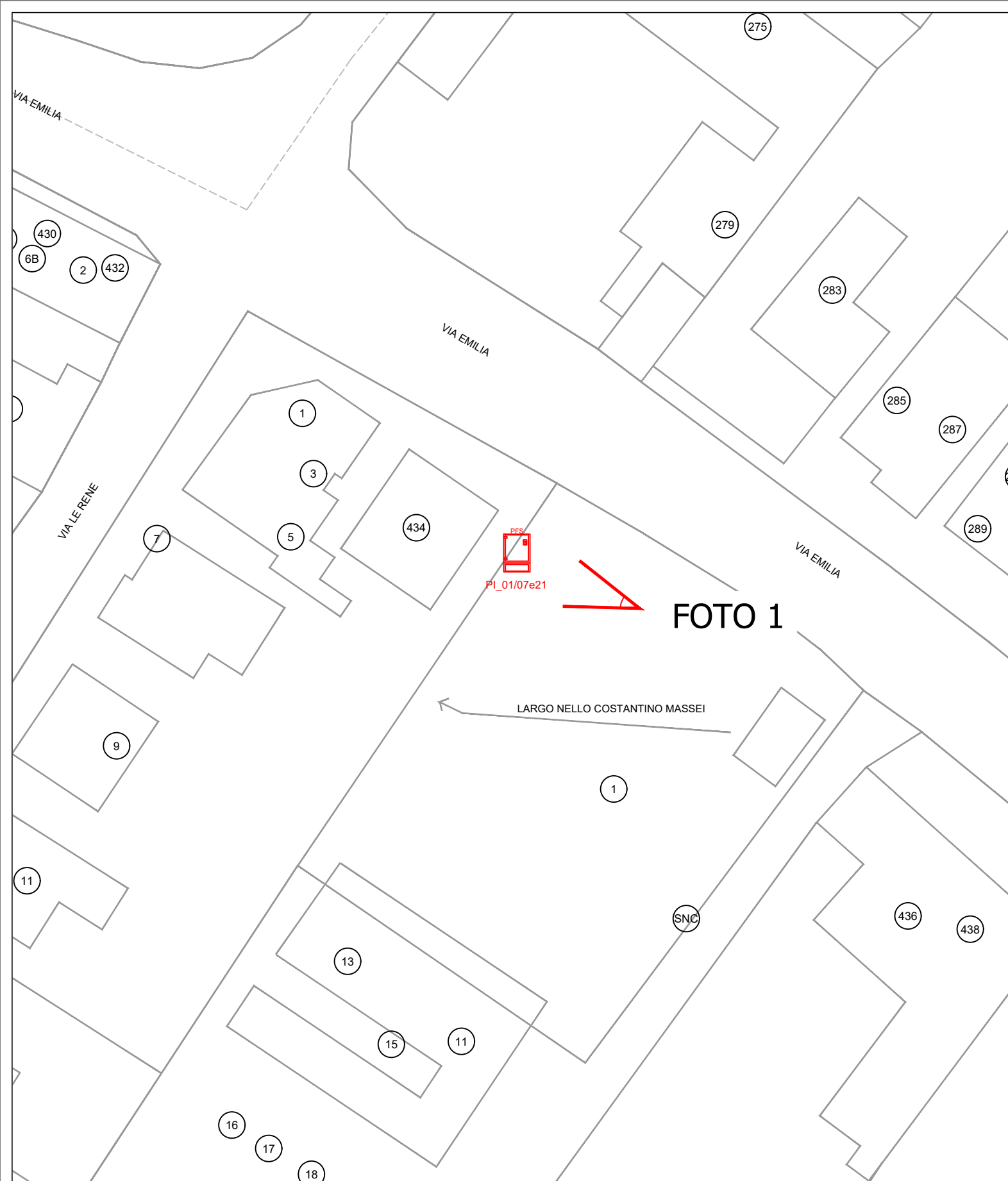

PFS
PI_01/07e21

FOTO 1

LARGO NELLO COSTANTINO MASSEI

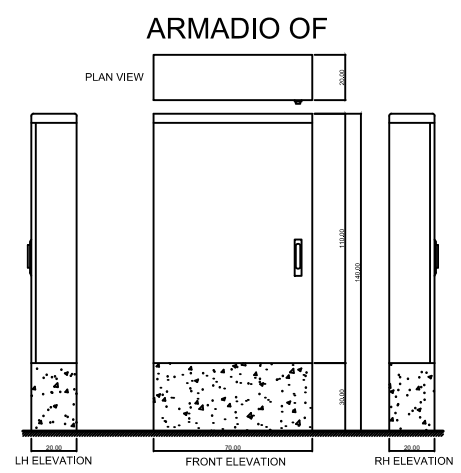
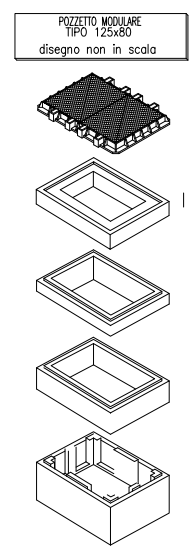

UBICAZIONE ARMADIO
PI_01 07e21
LARGO C.N MASSEI SNCI
43.68475506,10.42356584

LEGENDA

ARMADIO TECNICO IN VINCOLO PAESAGGISTICO

ARMADIO TECNICO NON IN VINCOLO PAESAGGISTICO



Comune di Pisa
Via degli Uffizi, 1 56100 Pisa (PI)
comune.pisa@postacert.toscana.it

COMMITTENTE

open fiber

REGIONAL MANAGER
REGIONE TOSCANA
MARCO GASPARINI

PROGETTISTA

accenture

REALIZZAZIONE, POSA IN OPERA E SERVIZIO DI MANUTENZIONE DI IMPIANTI IN FIBRA OTTICA

ISTANZA DI AUTORIZZAZIONE



ELABORATO

COROGRAFIA
COMUNE DI
PISA
AREA_EST

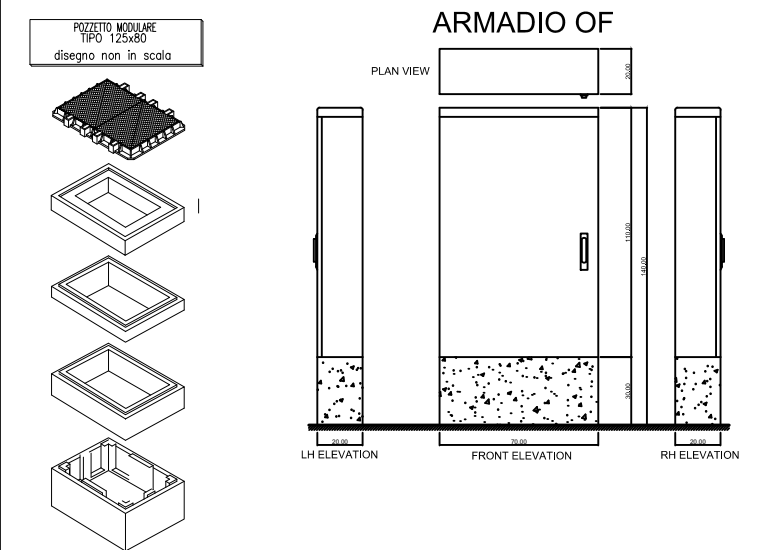
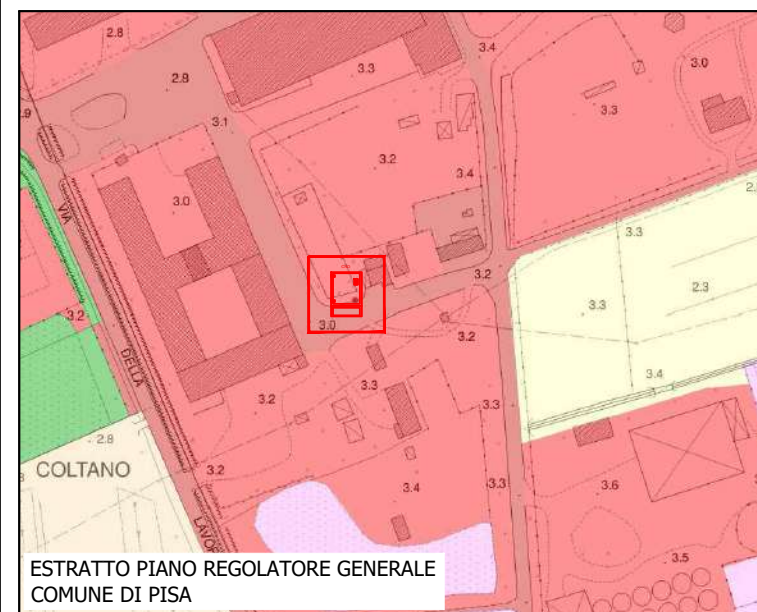
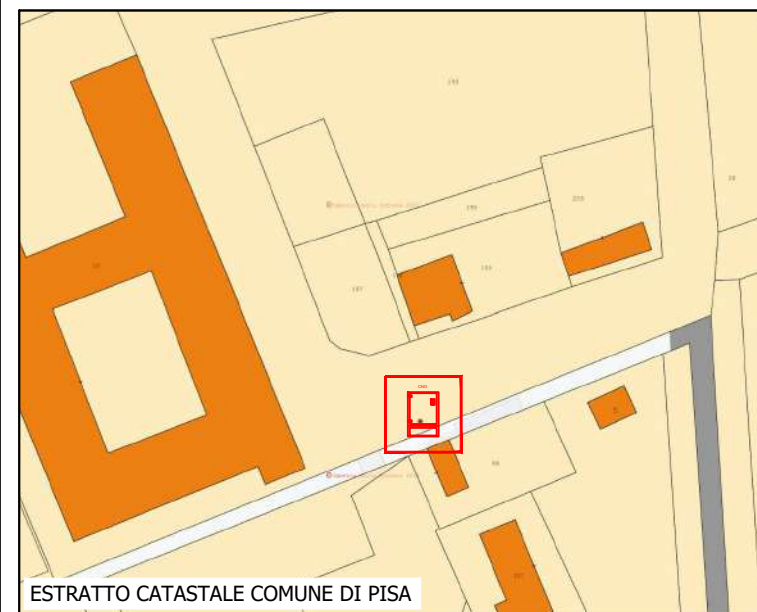
SCALA	CODICE PROGETTO
1: 500	PISA FINANZIATO
NOME FILE	TAVOLA
PISA-PL-A-AREA_EST	04
DATA 19/06/2023	Formato stampa A3



UBICAZIONE ARMADIO
 PI_01 07e22
 VIA PALAZZI 35
 43.63832154,10.39337480

LEGENDA
 ARMADIO TECNICO IN VINCOLO PAESAGGISTICO
 ARMADIO TECNICO NON IN VINCOLO PAESAGGISTICO



Comune di PISA
 Via degli Uffici, 1 56100 Pisa (PI)
 comune.pisa@postacert.toscana.it

COMMITTENTE

 REGIONAL MANAGER
 REGIONE TOSCANA
 MARCO GASPARINI

PROGETTISTA

REALIZZAZIONE, POSA IN OPERA E SERVIZIO DI MANUTENZIONE DI IMPIANTI IN FIBRA OTTICA



ISTANZA DI AUTORIZZAZIONE

ELABORATO
 COROGRAFIA
 COMUNE DI PISA
 AREA_EST

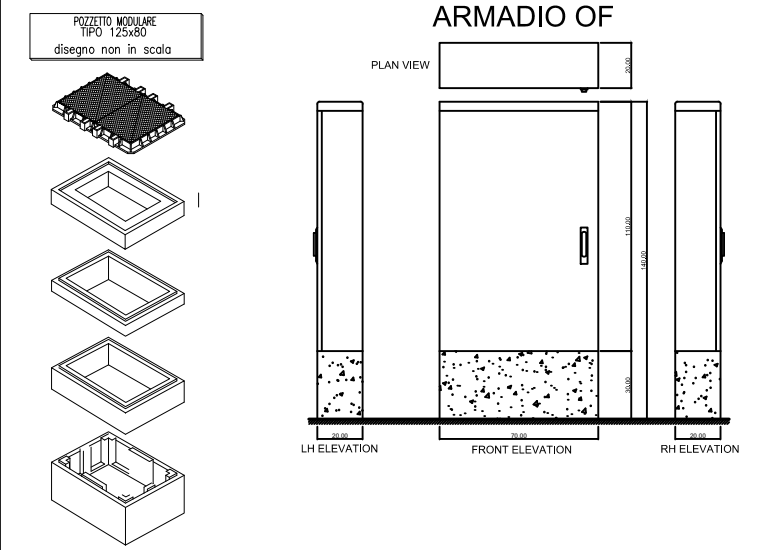
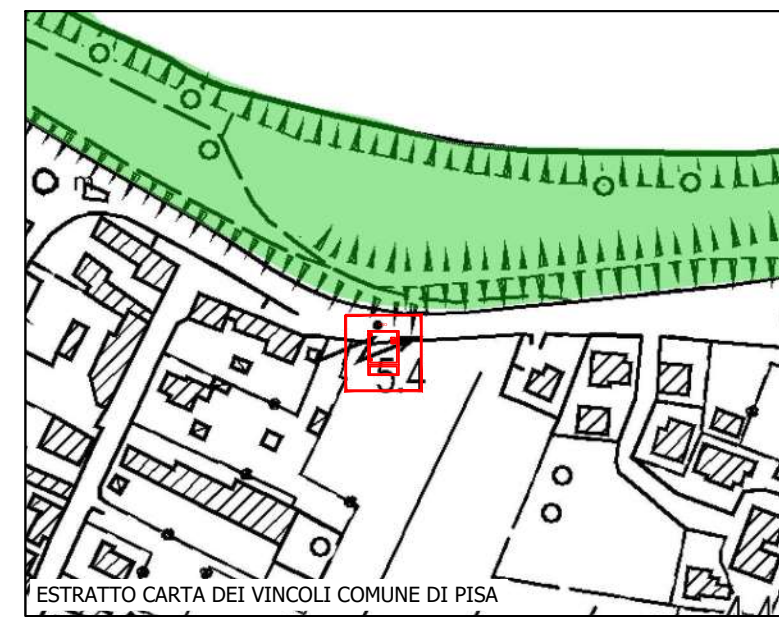
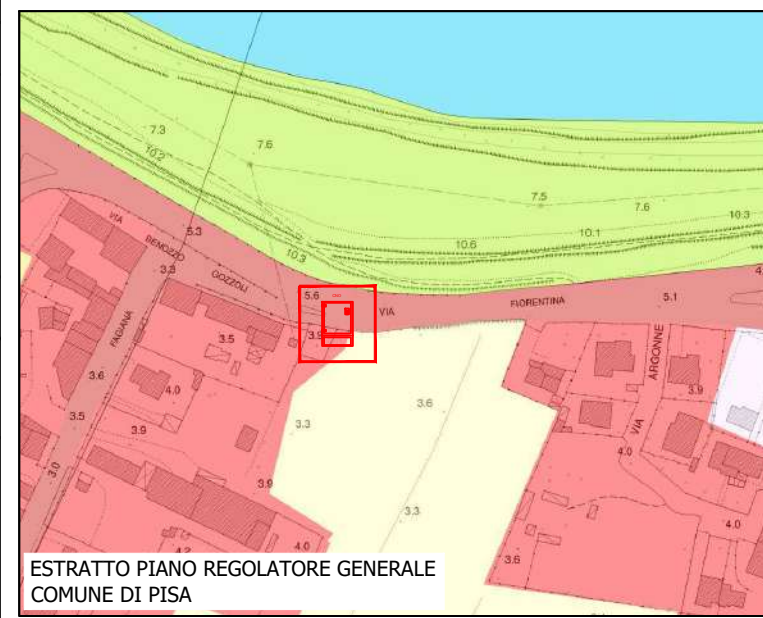
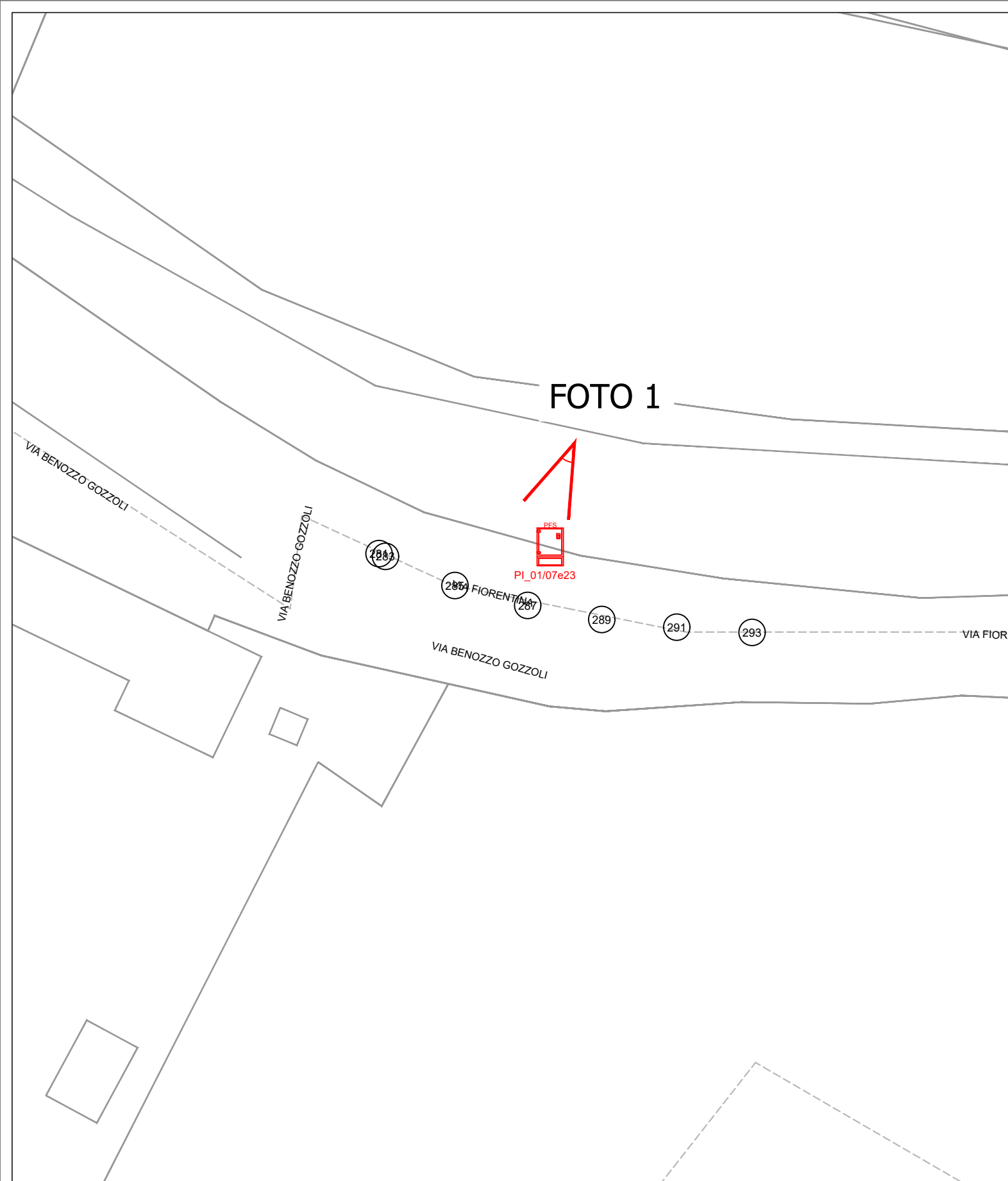
SCALA	CODICE PROGETTO
1: 500	PISA FINANZIATO
NOME FILE	TAVOLA
PISA-PL-A-AREA_EST	05
DATA 19/06/2023	Formato stampa A3



UBICAZIONE ARMADIO
 PI_01 07e23
 VIA FIORENTINA 330
 43.69521967, 10.43906366

LEGENDA
 ARMADIO TECNICO IN VINCOLO PAESAGGISTICO
 ARMADIO TECNICO NON IN VINCOLO PAESAGGISTICO



Comune di Pisa
 Via degli Uffizi, 1 56100 Pisa (PI)
 comune.pisa@postacert.toscana.it

COMMITTENTE



REGIONAL MANAGER
 REGIONE TOSCANA
 MARCO GASPARINI

PROGETTISTA



REALIZZAZIONE, POSA IN OPERA E SERVIZIO DI MANUTENZIONE DI IMPIANTI IN FIBRA OTTICA

ISTANZA DI AUTORIZZAZIONE

ELABORATO
 COROGRAFIA
 COMUNE DI PISA
 AREA_EST

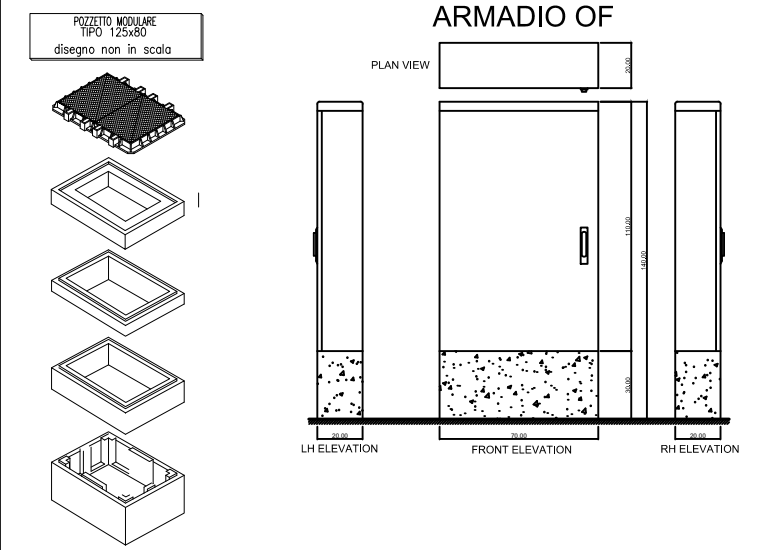
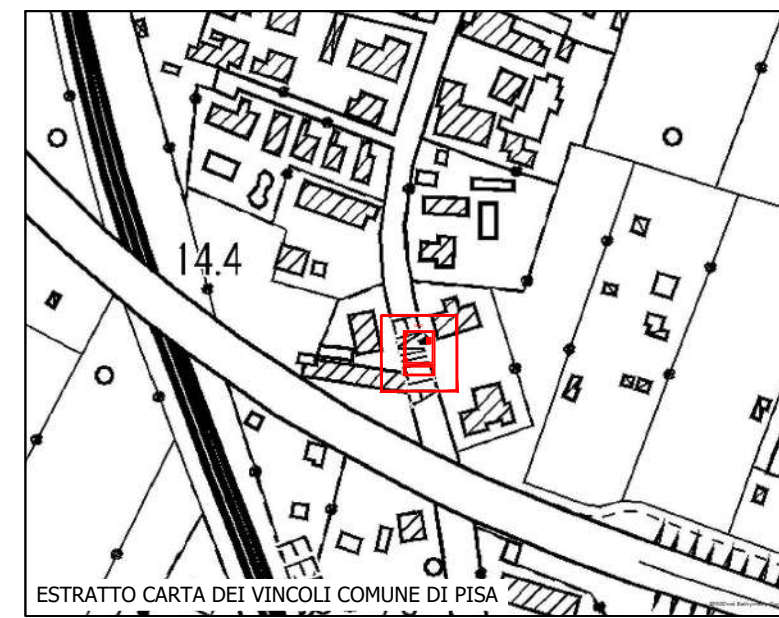
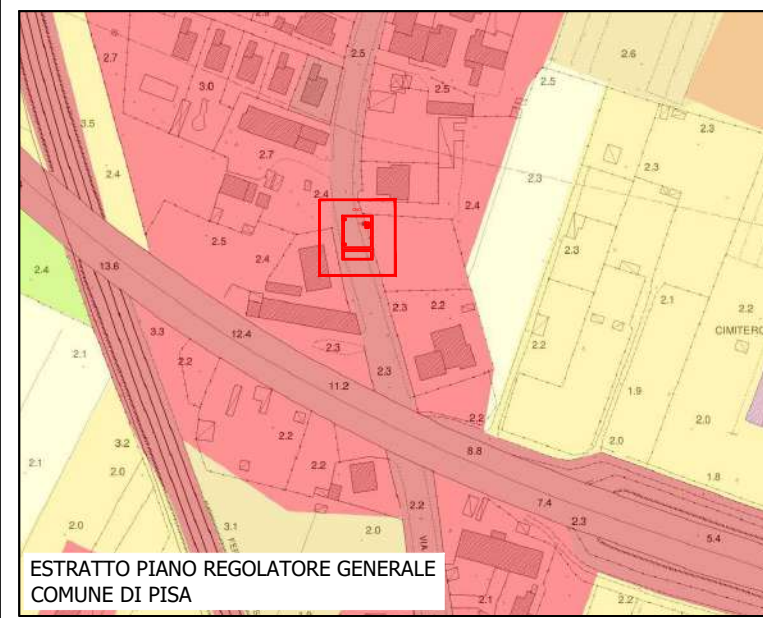
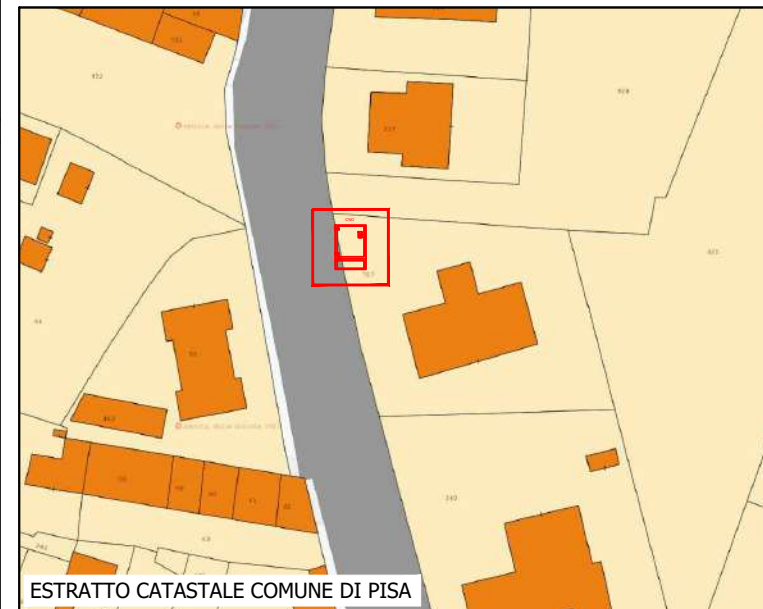
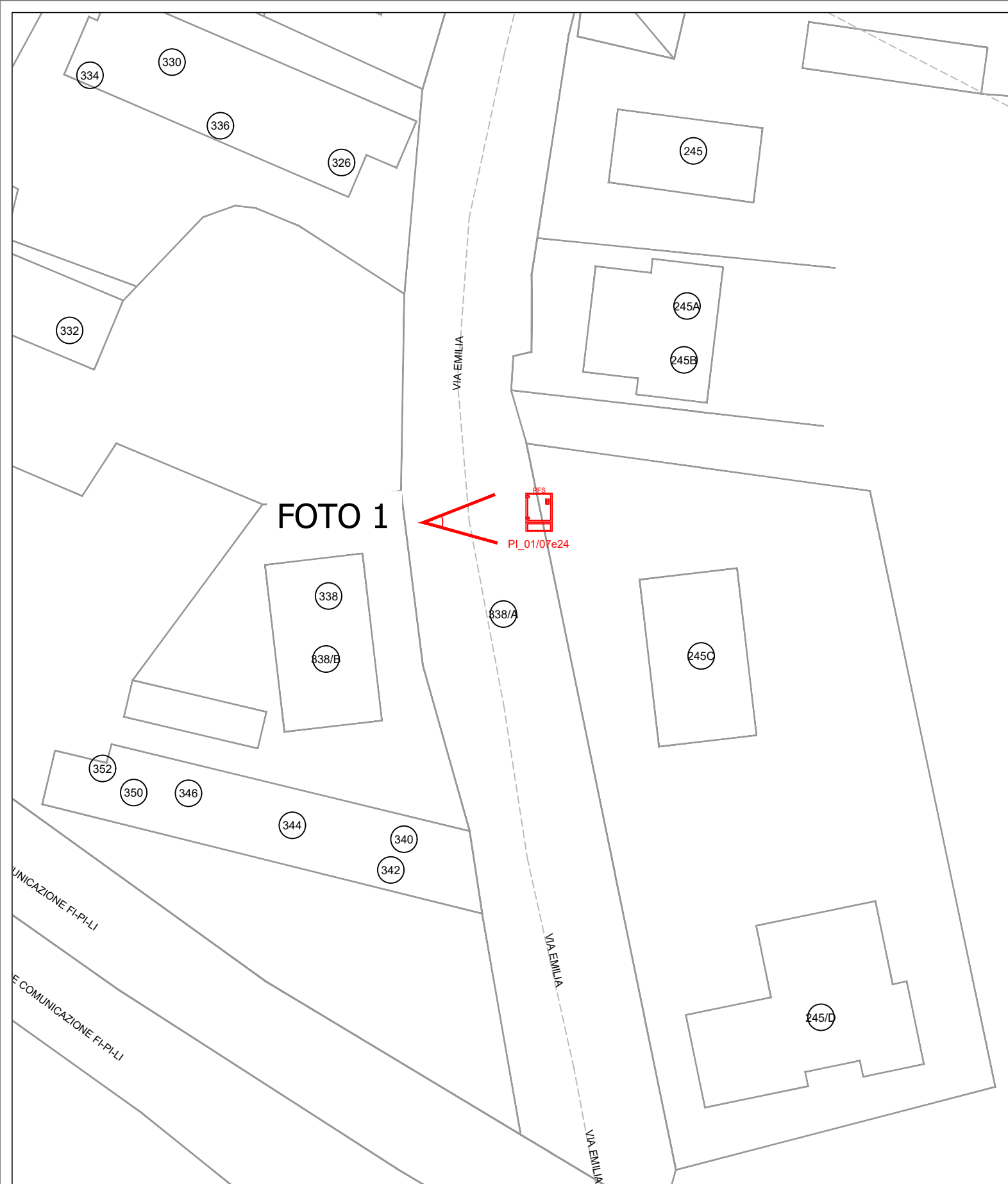

SCALA
1: 500
 NOME FILE
 PISA-PL-A-AREA_EST
 DATA 19/06/2023

CODICE PROGETTO
 PISA FINANZIATO
 TAVOLA
06
 Formato stampa A3



UBICAZIONE ARMADIO
 PI_01 07e24
 VIA EMILIA SNC
 43.69477029,10.4136838

LEGENDA

-  ARMADIO TECNICO IN VINCOLO PAESAGGISTICO
-  ARMADIO TECNICO NON IN VINCOLO PAESAGGISTICO



Comune di PISA
 Via degli Uffici, 1 56100 Pisa (PI)
 comune.pisa@postacert.toscana.it

COMMITTENTE

open fiber

REGIONAL MANAGER
 REGIONE TOSCANA
 MARCO GASPARINI

PROGETTISTA

accenture

REALIZZAZIONE, POSA IN OPERA E SERVIZIO DI MANUTENZIONE DI IMPIANTI IN FIBRA OTTICA

ISTANZA DI AUTORIZZAZIONE

ELABORATO

COROGRAFIA COMUNE DI PISA AREA_EST

SCALA	CODICE PROGETTO
1: 500	PISA FINANZIATO
NOME FILE	TAVOLA
PISA-PL-A-AREA_EST	07
DATA 19/06/2023	Formato stampa A3

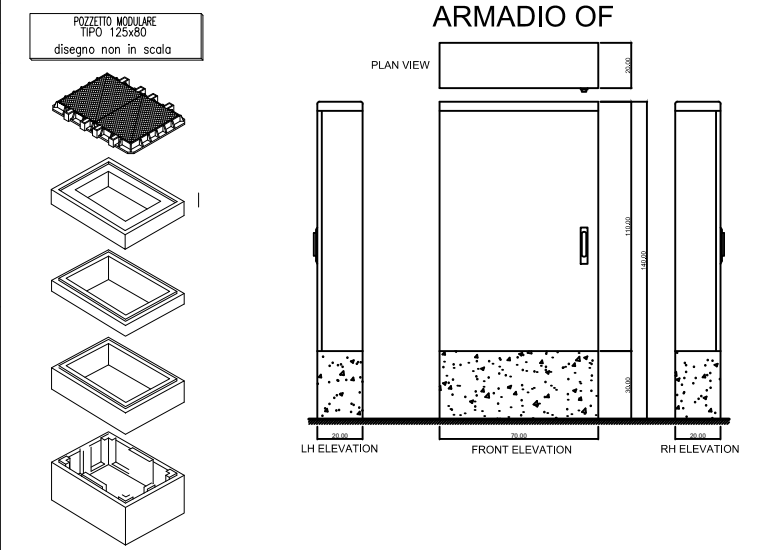
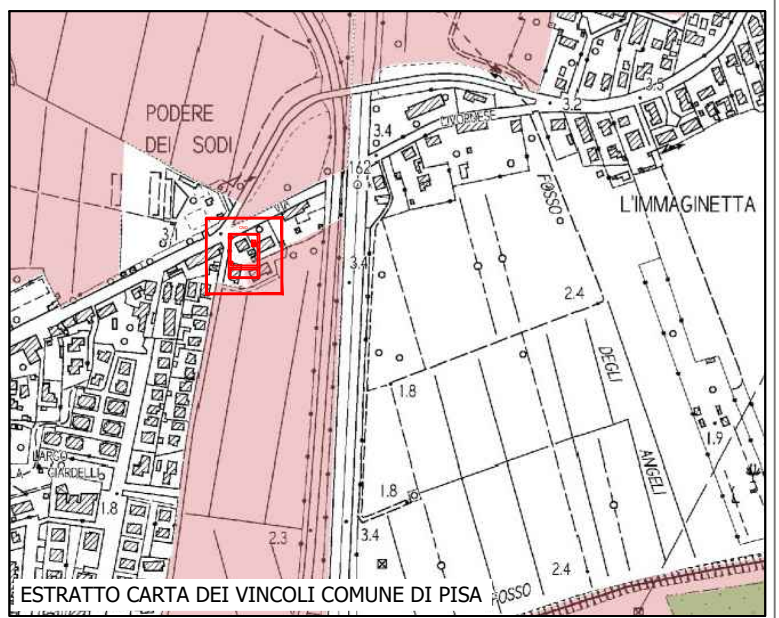
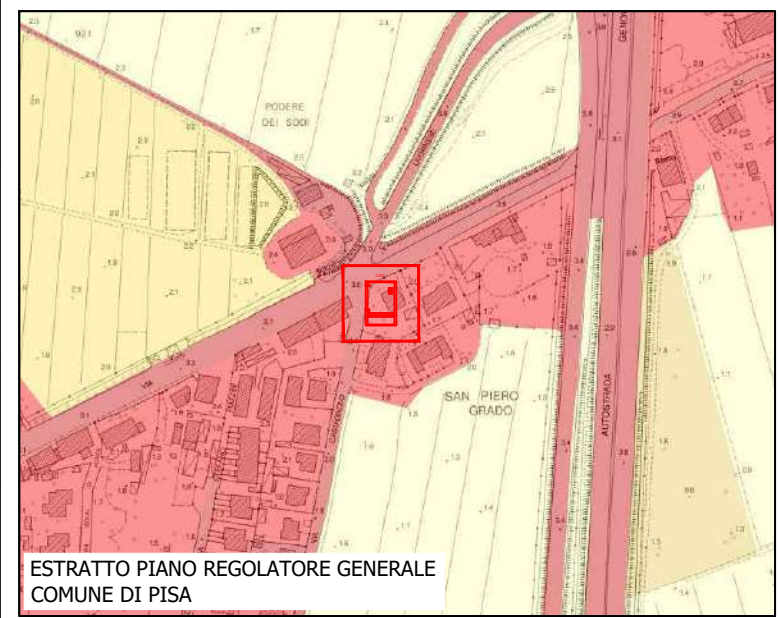
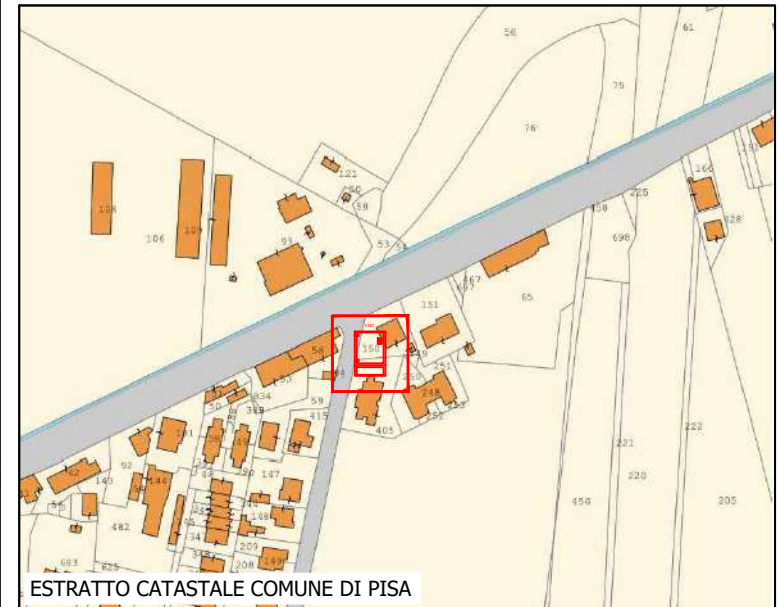
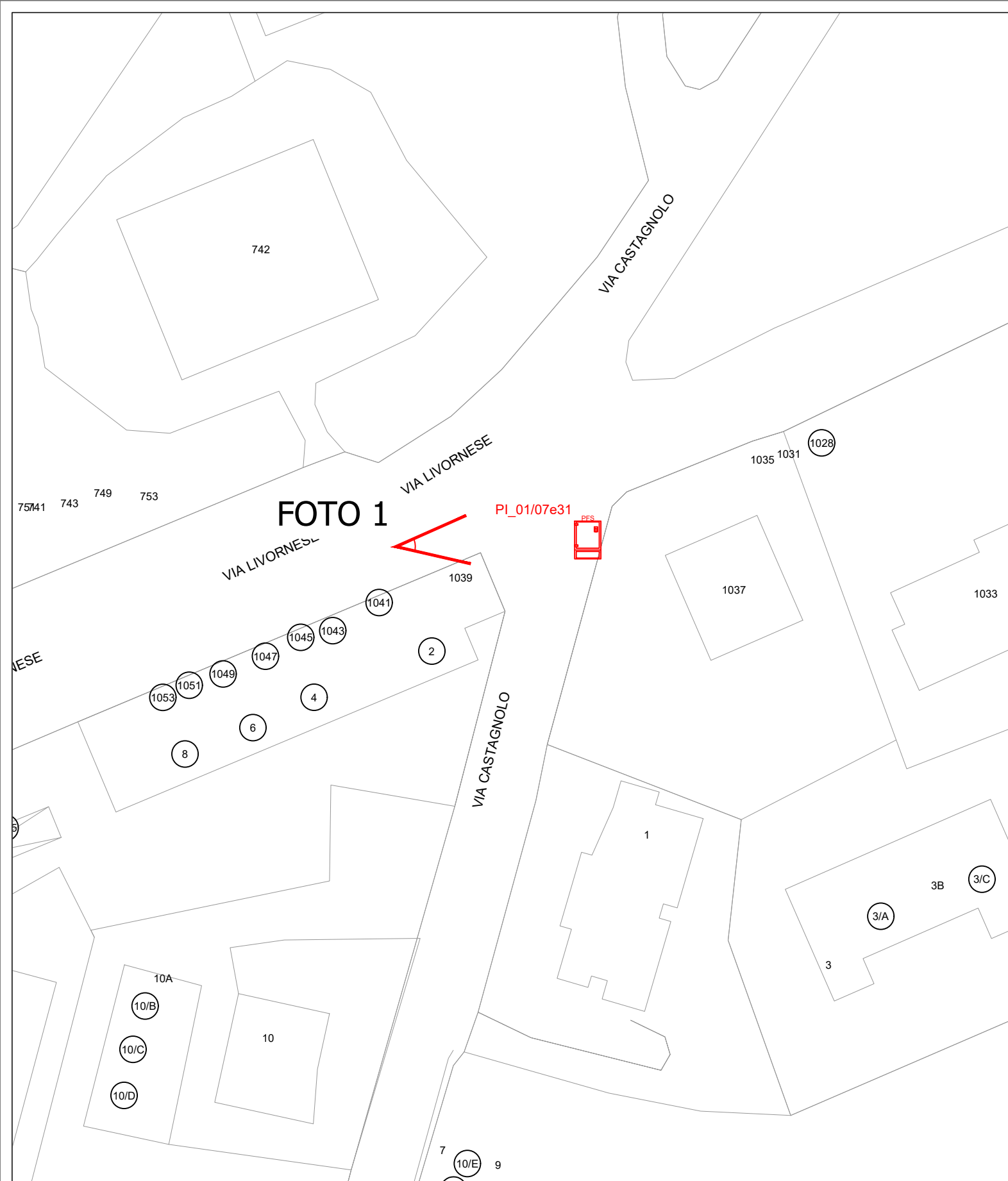

UBICAZIONE ARMADIO
 PI_01 07e31
 VIA CASTAGNOLO 2
 43.6810416,10.3520716

LEGENDA

ARMADIO TECNICO IN VINCOLO PAESAGGISTICO

ARMADIO TECNICO NON IN VINCOLO PAESAGGISTICO

Comune di Pisa
 Via degli Uffici, 1 56100 Pisa (PI)
 comune.pisa@postacert.toscana.it

COMMITTENTE

open fiber

REGIONAL MANAGER
 REGIONE TOSCANA
 MARCO GASPARINI

PROGETTISTA

accenture

REALIZZAZIONE, POSA IN OPERA E SERVIZIO DI MANUTENZIONE DI IMPIANTI IN FIBRA OTTICA

ISTANZA DI AUTORIZZAZIONE

ELABORATO

COROGRAFIA
 COMUNE DI PISA
 PFP01_07/E3

SCALA	CODICE PROGETTO
1: 500	PISA FINANZIATO
NOME FILE	TAVOLA
PISA-PL-A PFP01_07/E3	08
DATA 18/04/2023	Formato stampa A3

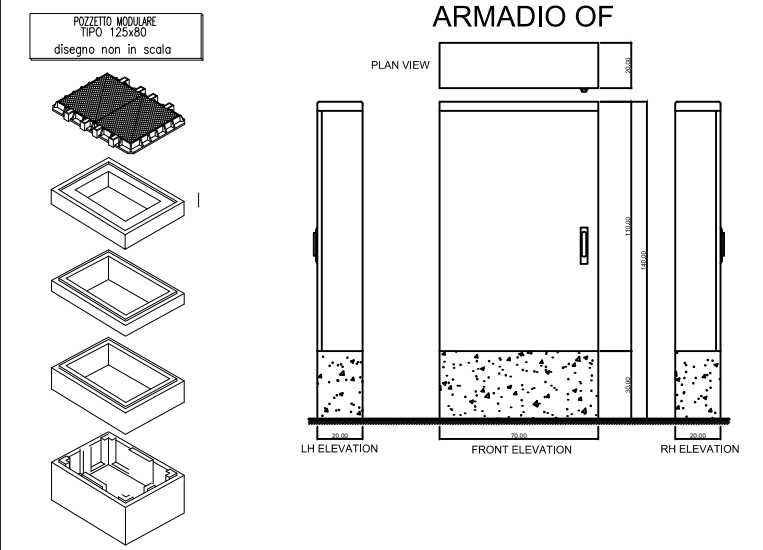
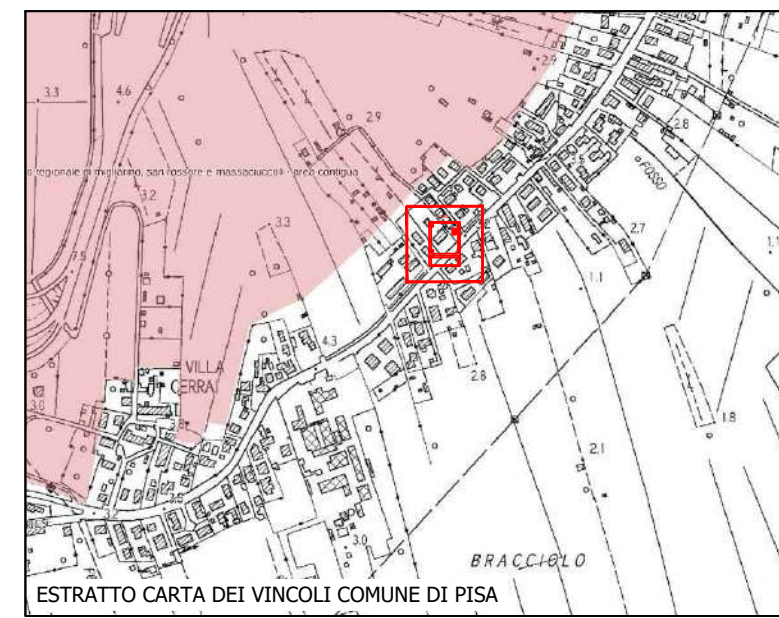
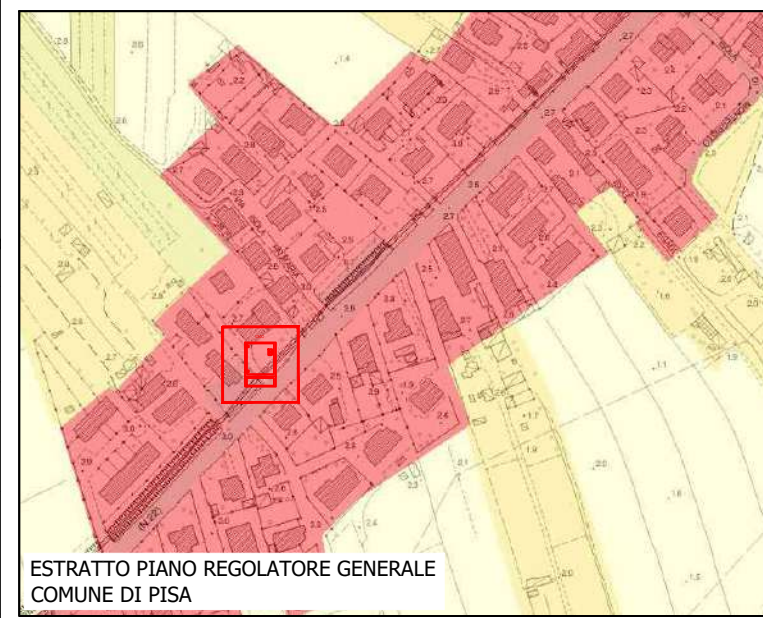
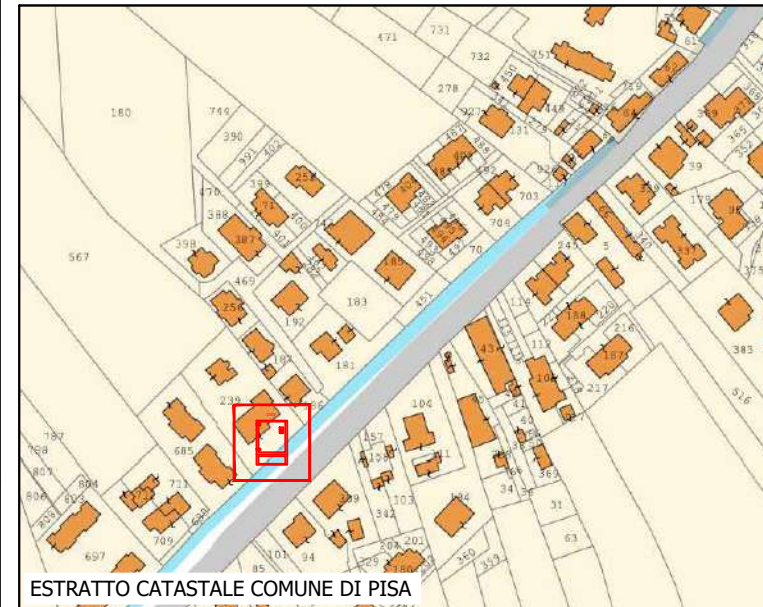
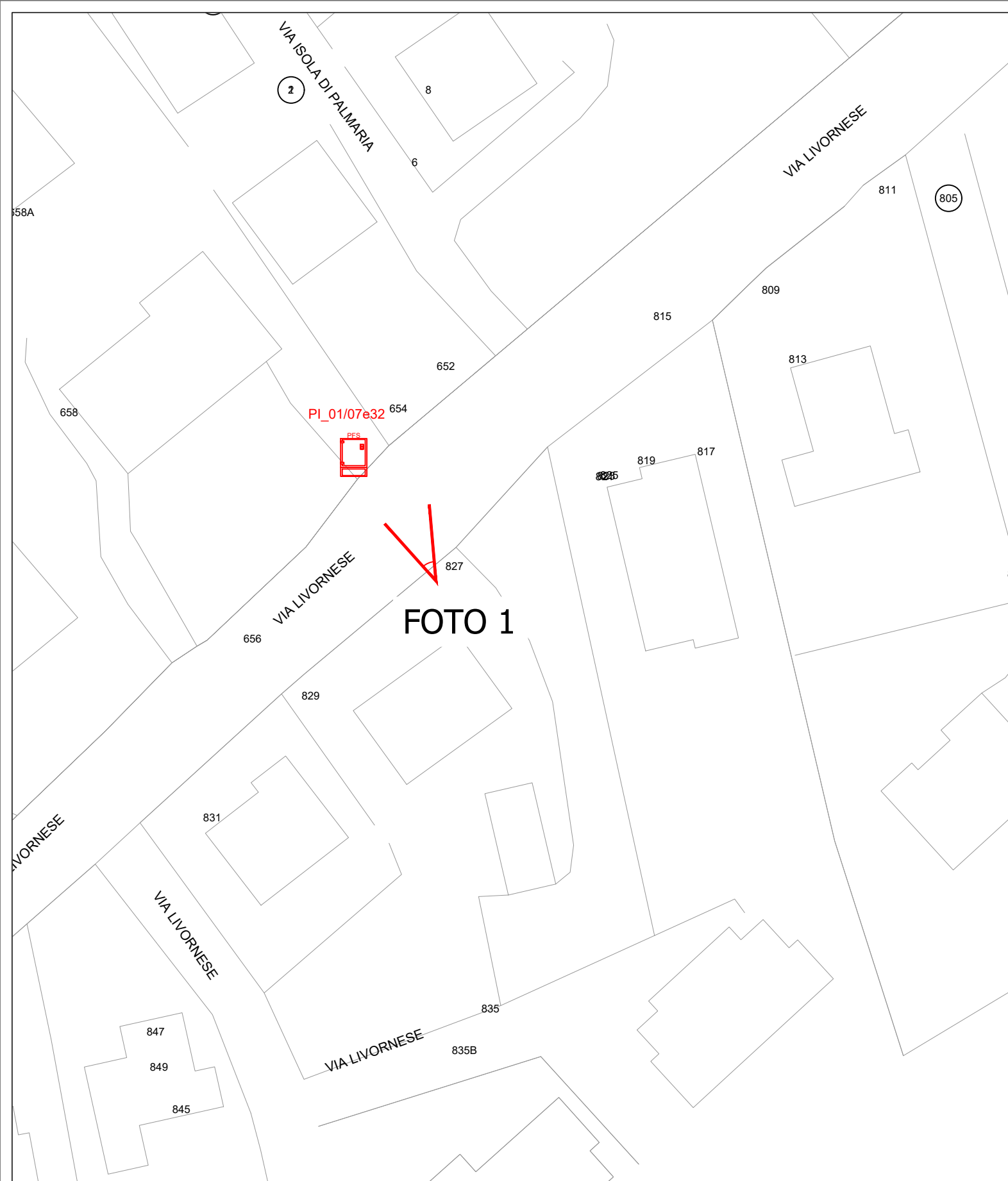

UBICAZIONE ARMADIO
 PI_01 07e32
 VIA LIVORNESE 654
 43.6859229,10.3633027

LEGENDA

ARMADIO TECNICO IN VINCOLO PAESAGGISTICO

ARMADIO TECNICO NON IN VINCOLO PAESAGGISTICO



Comune di PISA
 Via degli Uffici, 1 56100 Pisa (PI)
 comune.pisa@postacert.toscana.it

COMMITTENTE

open fiber

REGIONAL MANAGER
 REGIONE TOSCANA
 MARCO GASPARINI

PROGETTISTA

accenture

REALIZZAZIONE, POSA IN OPERA E SERVIZIO DI MANUTENZIONE DI IMPIANTI IN FIBRA OTTICA

ISTANZA DI AUTORIZZAZIONE

ELABORATO

COROGRAFIA
 COMUNE DI PISA
 PFP01_07/E3

SCALA	CODICE PROGETTO
1: 500	PISA FINANZIATO
NOME FILE	TAVOLA
PISA-PL-A PFP01_07/E3	09
DATA 18/04/2023	Formato stampa A3

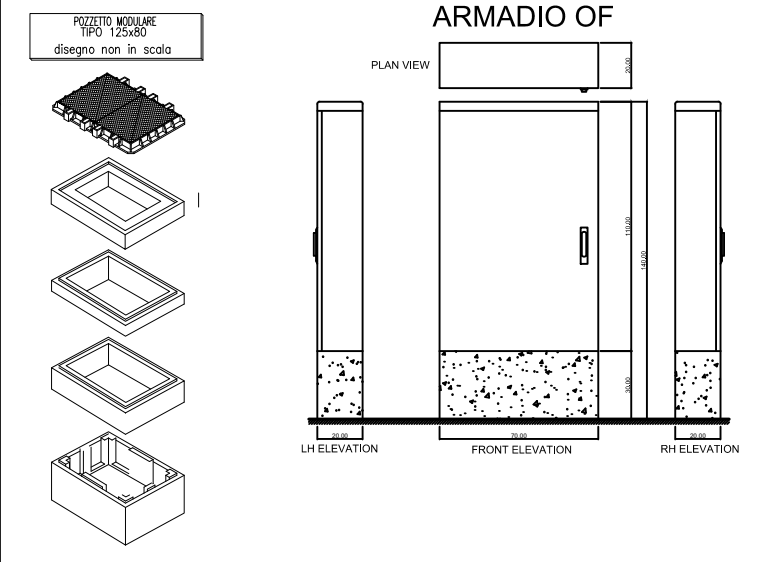
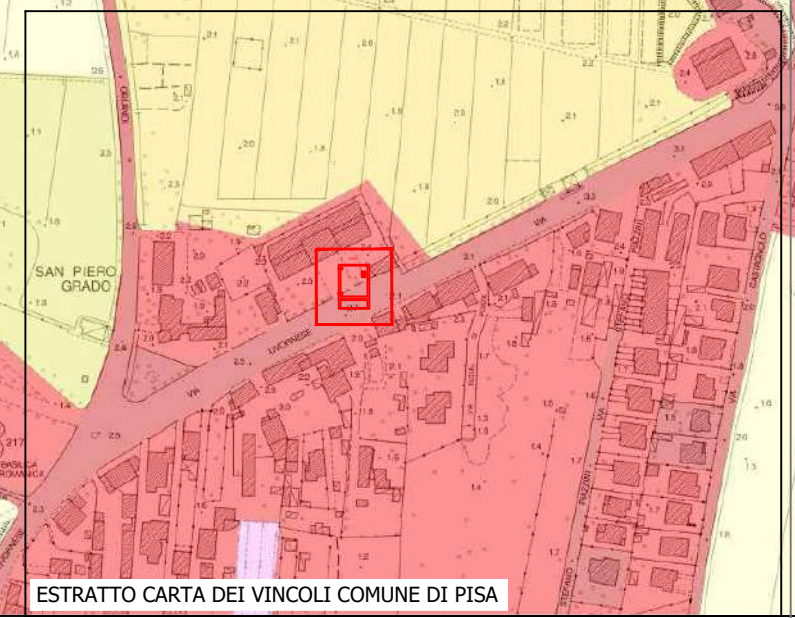
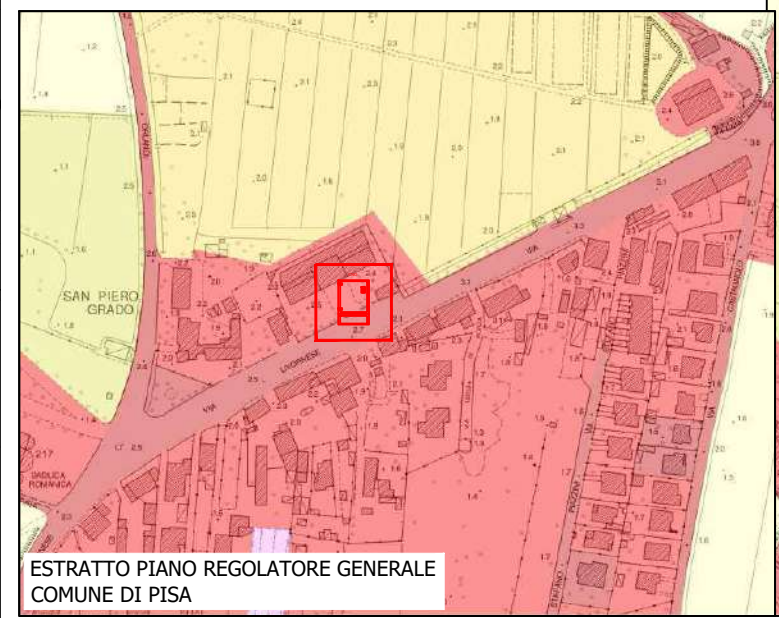
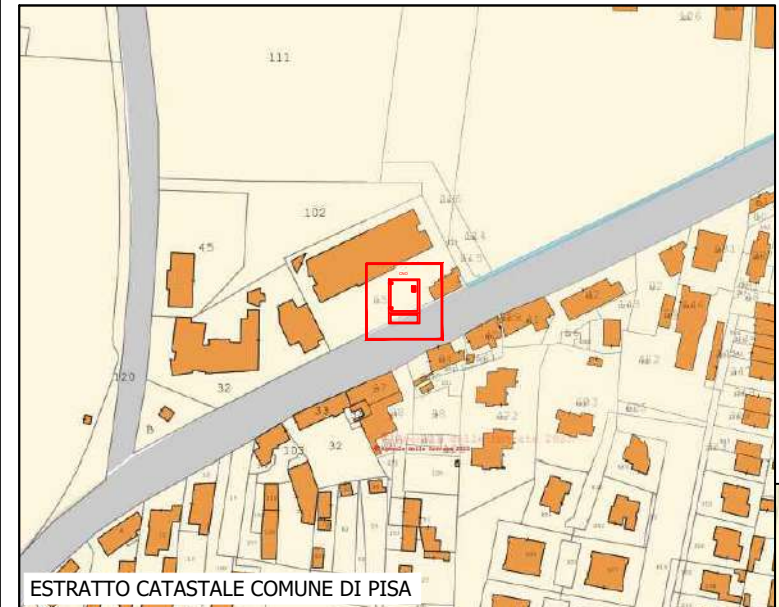
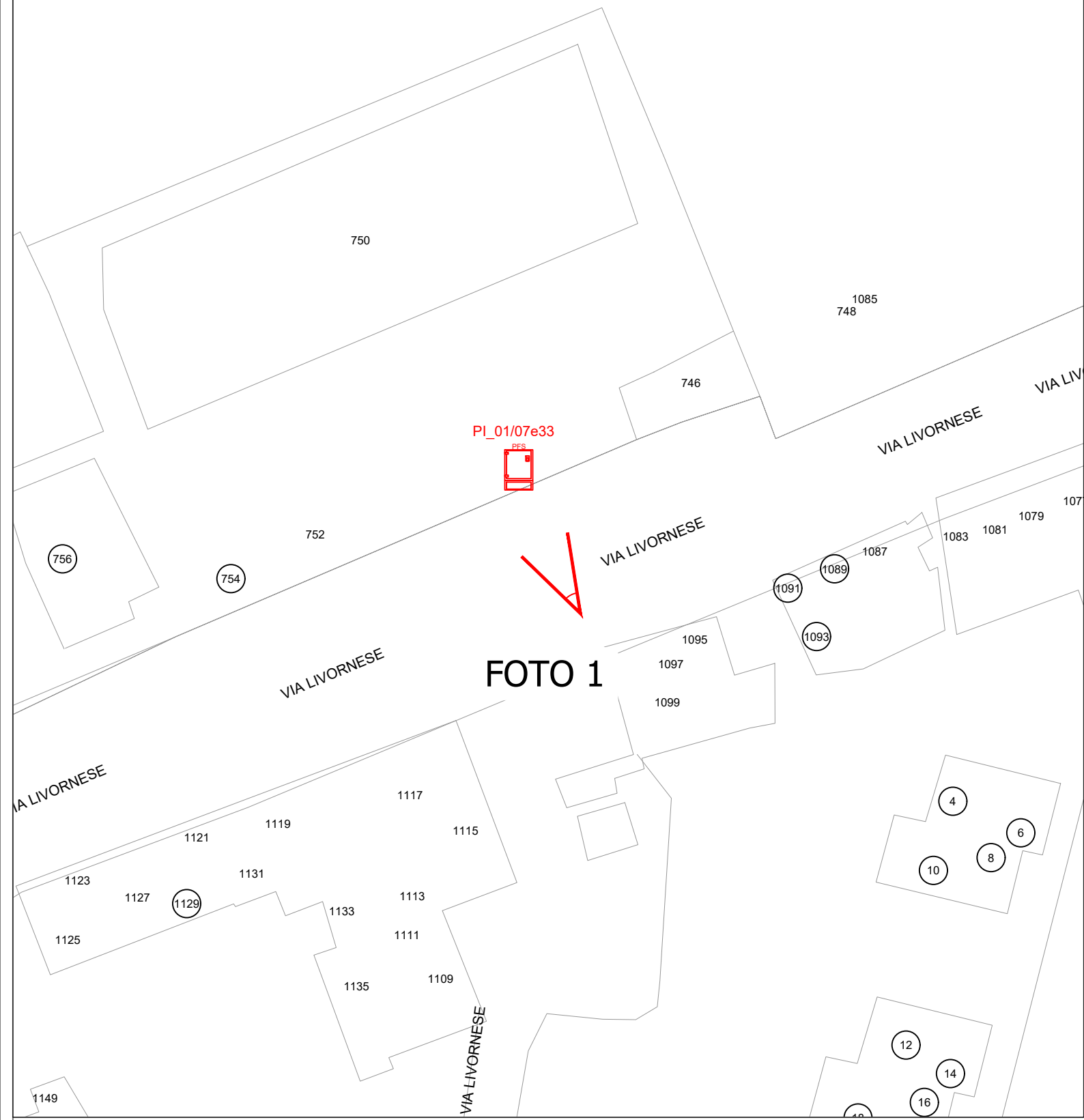

UBICAZIONE ARMADIO
 PI_01 07e33
 VIA LIVORNESE 750
 43.6803317,10.3493197

LEGENDA

 ARMADIO TECNICO IN VINCOLO PAESAGGISTICO

 ARMADIO TECNICO NON IN VINCOLO PAESAGGISTICO



Comune di Pisa
 Via degli Uffizi, 1 56100 Pisa (PI)
 comune.pisa@postacert.toscana.it

COMMITTENTE

open fiber

REGIONAL MANAGER
 REGIONE TOSCANA
 MARCO GASPARINI

PROGETTISTA

accenture

REALIZZAZIONE, POSA IN OPERA E SERVIZIO DI MANUTENZIONE DI IMPIANTI IN FIBRA OTTICA

ISTANZA DI AUTORIZZAZIONE

ELABORATO

COROGRAFIA
 COMUNE DI PISA
 PFP01_07/E3

SCALA	CODICE PROGETTO
1: 500	PISA FINANZIATO
NOME FILE	TAVOLA
PISA-PL-A PFP01_07/E3	10
DATA 18/04/2023	Formato stampa A3